

STIR IT UP LUX

QUICK START GUIDE



HOW TO VIDEOS
VIDEO TUTORIAL
INSTRUCTIEVIDEO'S
TUTORIELS
VIDEOANLEITUNGEN
VÍDEOS GUÍA
使用方法视频
하는 법 영상
使用方法動画

ATTENTION: PLEASE READ QUICK START GUIDE BEFORE USE

**ATTENTION: PRIÈRE DE LIRE LE GUIDE DE
DÉMARRAGE RAPIDE AVANT UTILISATION**

ATENCIÓN: LEA LA GUÍA DE INICIO RÁPIDO ANTES DE USARLO

BEACHTUNG: VOR DEM GEBRAUCH BITTE DIE SCHNELLSTARTANLEITUNG LESEN

ATTENZIONE: LEGGERE LA GUIDA DI AVVIAMENTO RAPIDO PRIMA DEL USO

OPGELET: VOOR HET GEBRUIK DE SNELSTARTGIDS LEZEN

注意：ご使用前にクイックスタートガイドを必ずお読みください。

提示：使用前請閱讀快捷使用說明

주의：사용 전에 빠른 시작 가이드를 읽어 주십시오.

INDEX

English	2
Français	14
Español	26
Deutsche	38
Italiano	51
Nederlands	63

ENGLISH

PRODUCT MAP

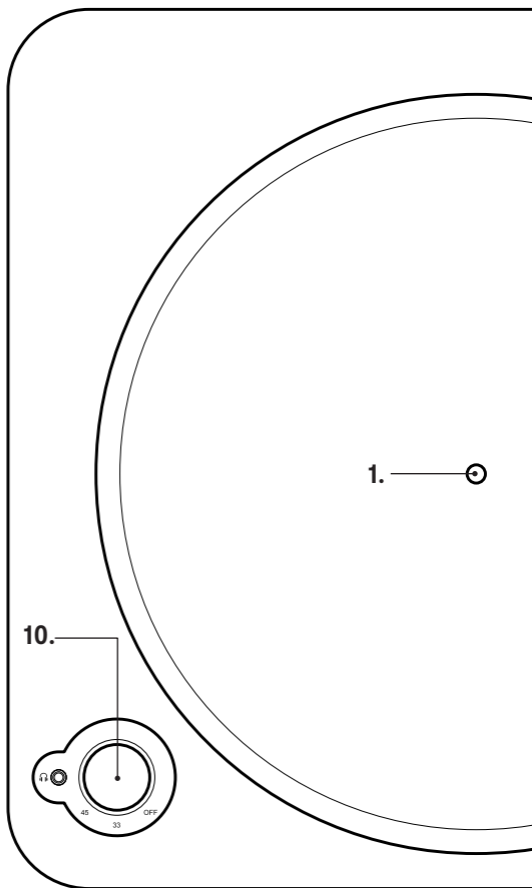

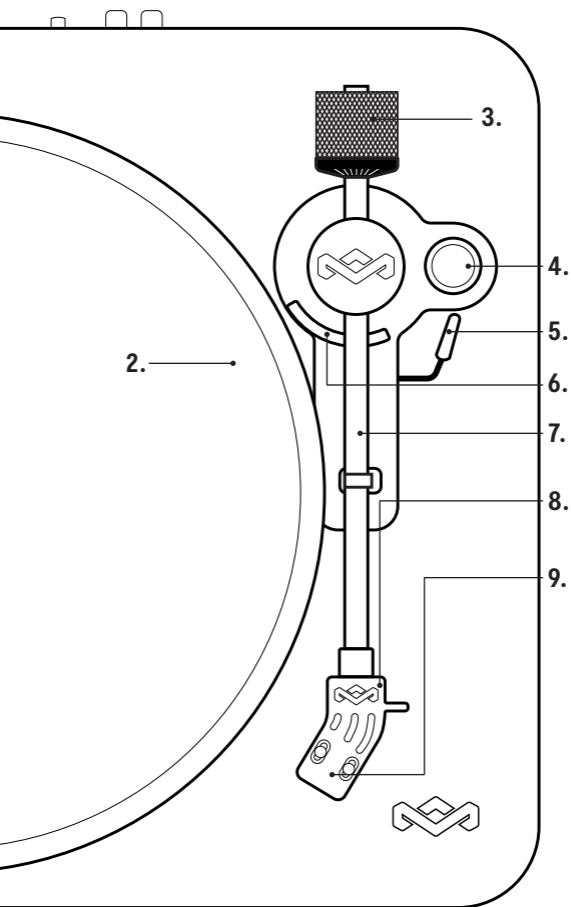

LEGEND

1. Spindle
2. Turntable
3. Balance Weight
4. Anti-Skating Knob
5. Tone Arm Lift Level
6. Tone Arm Rest Holder
7. Tone Arm
8. Stylus
9. Needle Cover
10. Multi-Function Button
11. Power Adaptor With 4 Interchangeable Plugs
12. 45 Adaptor
13. Stylus Pressure Gauge

11.

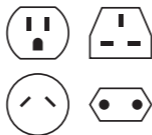
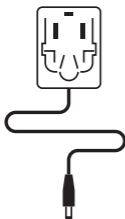

12.



13.

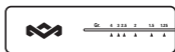

FUNCTION LAYOUT

LEGEND

- A. RCA Line Out
- B. Pre-Amp Switch Button
- C. USB-C Out
- D. Off/33/45 Knob
- E. Headphone Jack
- F. Bluetooth® Button
- G. - VOL + Knob
- H. Anti-skating Knob

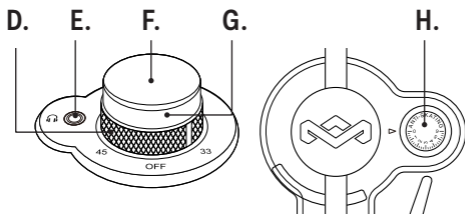
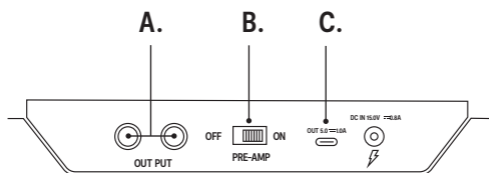

SETUP

ATTACHING THE DRIVE BELT

Note: The drive belt comes pre-installed. However, if when you open the turntable, there is no visible belt around the sub-platter and motor. Please re-fit the belt.

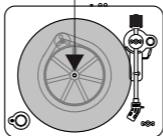
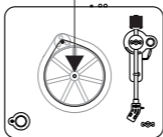
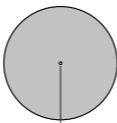
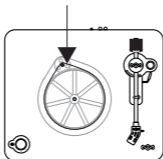

- To fit the belt, put the belt on the motor (this is the gold spindle), then keeping the belt tight stretch it around the sub-platter. Once in place make sure the belt is flat and not twisted.
- Now place the glass platter on the black sub-platter, by aligning the centre holes.
- Now place the slip mat on the glass platter, again aligning the centre holes. The platter should be attached to the base.

BALANCING THE TONEARM

Option 1 (Without Stylus Pressure Gauge):

- Push the Balance Weight on the tone arm until you feel a click.
- Remove the stylus needle cover, before attempting to balance the tonearm.
- Unclip the tonearm and from its rest, and make sure it is floating freely.
- Rotate the Balance Weight back and fourth until the tone arm is parallel with the platter.

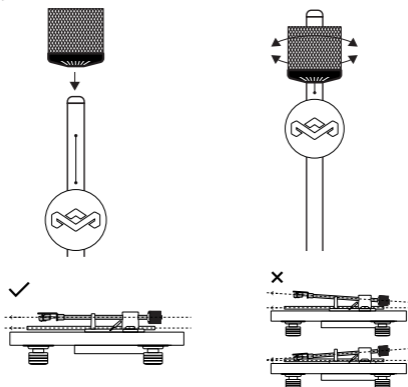

- Now place the tonearm back into its rest and clip it in so it is secure. Now hold the balance weight so it cannot move, and with your other hand rotate the front dial until it is at 0. Your tonearm is now zeroed.
- Now you need to add the correct tracking force for the stylus. You do this by now rotating the whole balance weight counter clock-wise until the correct weight is added. The correct tracking force for this stylus = 1.5g – 2.5g (2.0g standard)

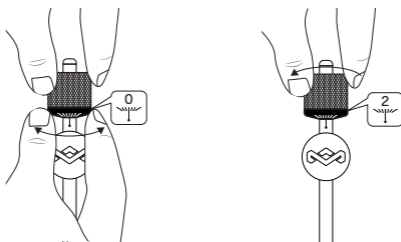

NOTE: Once finished, if not using the turntable to play a record, put the stylus needle cover back on to protect the stylus when not in use.

Option 2 (Using Stylus Pressure Gauge):

- Push the Balance Weight on the tone arm until you feel a click.
- Remove the stylus needle cover, before attempting to balance the tonearm.
- Unclip the tonearm and from its rest, and make sure it is floating freely.
- Place the stylus pressure gauge onto the platter.
- Place the stylus onto the 2-gram mark (recommended Tracking force for our stylus).
- Rotate the balance weight back and forth until the pressure gauge is level. Ensure that the needle stays on the 2g mark.

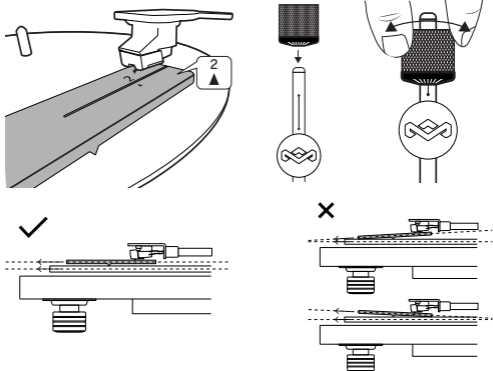

ANTI-SKATING

Anti-skate applies a small outward force to the tonearm. This is to counteract the tendency of the arm to move inward (skate) toward the centre of the record, especially as the record approaches the centre of the record.

The Anti-Skate should match the tracking force added. So for our turntable, set to 2.

PLAYING A RECORD

1. Make sure the Stir It Up Lux is connected to the power adapter and a wall outlet, and the outlet is switched on.
2. Put a vinyl on the turntable.

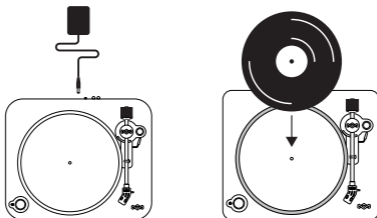

3. Make sure the stylus needle cover is removed.
4. Turn the RPM dial to the correct speed for the record. E.g. 45 / 33

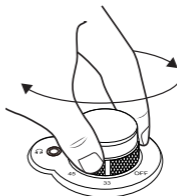
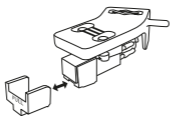

5. If wanting to play via Bluetooth – Please see the “Bluetooth Pairing” section and then come back here once connected to an output device. If wanting to play via Line out or Headphone out – please check their sections on how to connect the output device. And then come back here.
6. Lift the tonearm via the lift lever and move the tonearm head to the edge of the record.
7. Now lower the tonearm, by lowering the tone arm lift lever.

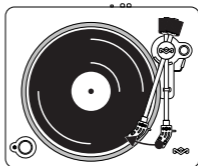
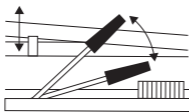

NOTE: The turntable platter will auto-start spinning once the tonearm is above the platter.

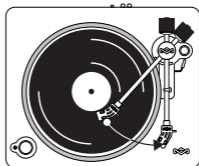
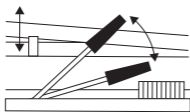

8. Once the record is finished, the turntable platter will auto stop. Lift the tonearm and place it on the tonearm rest. To listen to the B side of your record, flip the record and repeat the above from step 6.

NOTE: Once finished listening to a record, make sure the stylus needle cover is re-attached to protect the stylus.

Do not try to adjust the balance weight or anti-skate while playing a record, this could break the stylus needle and scratch the record.

Do not try to turn the turntable platter manually. Moving or jarring the turntable without securing the tonearm, could result in damage to the tonearm.

Re-secured the tone arm before transportation to protect the needle.

Remove the balance weight before transportation to prevent damage or breakage to the unit.

BLUETOOTH® PAIRING

- Power on the external Bluetooth® device first before turning on the BT function on the Turntable.
- Press the BT button on the turntable (MFB) to enable the unit to search the Bluetooth® device till BT indicator light becomes solid. This will indicate your devices are paired.

NOTE: If the Turntable does not pair with your Bluetooth® device within 30 seconds, press the Bluetooth® search button again on the turntable and it should pair.

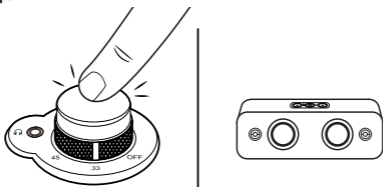

- Blue LED light flash
- Blue LED light stable

DISCONNECT BLUETOOTH® PAIRING

Long press and hold the BT button till the BT indicator light turns off. Turntable will then disconnect from external device.

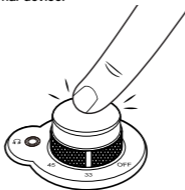

- Blue LED light will turn to Red. This indicates Bluetooth is off, but turntable still has power.

VOLUME CONTROL

Increase Volume: Rotate the Volume Knob clockwise.

Decrease Volume: Rotate Volume Knob counter clockwise.

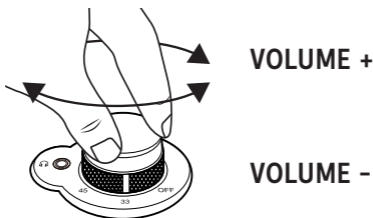

HEADPHONE OPERATION VIA HEADPHONE JACK

Connect a set of headphone (not included) in the headphone jack.

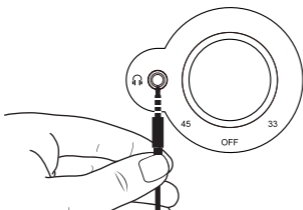

Note: Never put on the headphone till you have plugged in the headphone plug

NON BLUETOOTH® CONNECTION SETUP

LED will also be solid RED when headphones are plugged in.

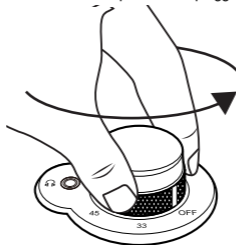

CAUTION: Switch off the power to all equipment before making connections. Read the instructions of each component you intend to use with this unit. Be sure to insert each plug securely. To prevent hum and noise, avoid bundling the signal interconnection cables together with the AC power cord.

LINE OUT OPERATION

1. Switch the PRE-AMP OFF/ON SWITCH to ON position.
2. Plug one end of the RCA cable (included) into the LINE OUT socket at the back of the unit. Be sure to match the color with the socket.
3. Plug the other end of the cable into the LINE IN socket of your home amplifier device.
4. Switch on the unit and the amplifier device you connected.
5. Adjust the volume on the amplifier device.

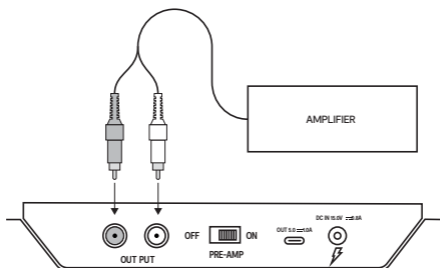

USB-C OUT PORT

You can use the USB-C out port to charge any of your devices from here. We can recommend charging a House of Marley Speaker from this to save on plug adaptors.

FRANÇAIS

LE PLAN DU PRODUIT

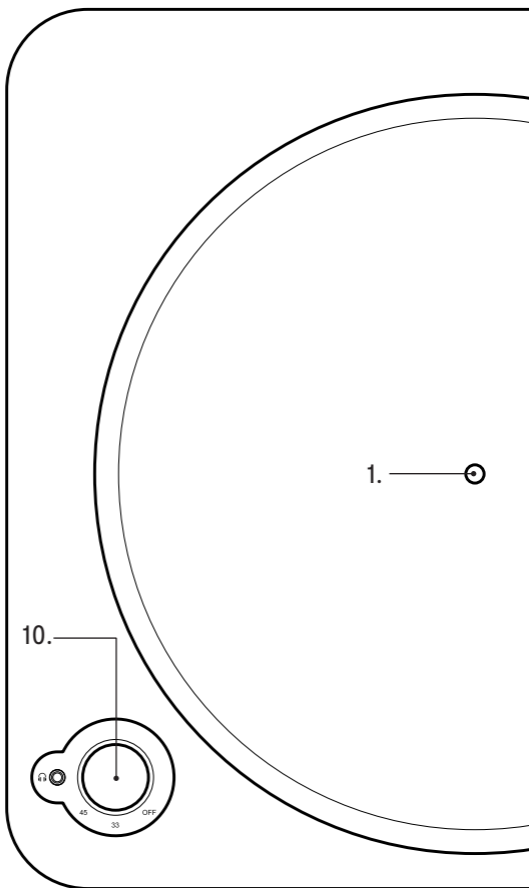

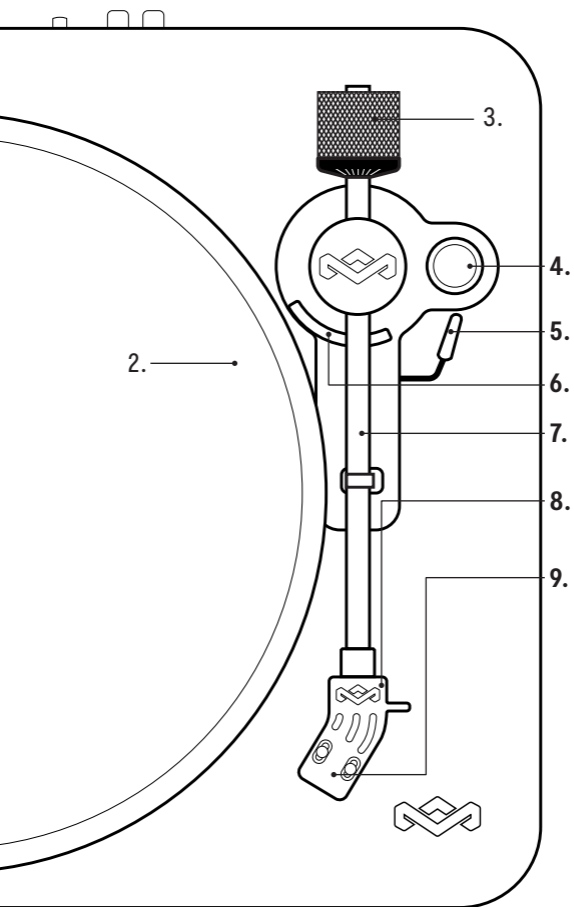

LÉGENDE

1. Axe
2. Platine
3. Contrepoids
4. Bouton Anti-skating
5. Niveau De Relevage Du Bras De Lecture
6. Support Du Bras De Lecture
7. Bras De Lecture
8. Pointe De Lecture
9. Couvercle De L'aiguille
10. Bouton multifonction
11. Adaptateur D'alimentation Avec 4 Fiches Interchangeables
12. Adaptateur 45
13. Balance mécanique pour pointe de lecture

11.

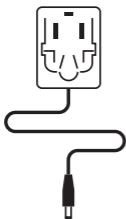

12.

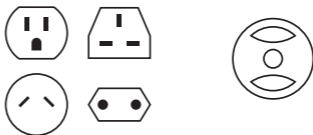

13.

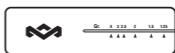

PRÉSENTATION DES FONCTIONS

LÉGENDE

- A. Sortie Ligne RCA
- B. Interrupteur De Préamplificateur
- C. Sortie USB-C
- D. Bouton Arrêt/33/45
- E. Prise De Casque
- F. Bouton Bluetooth®
- G. Bouton - VOL +
- H. Bouton Anti-skating

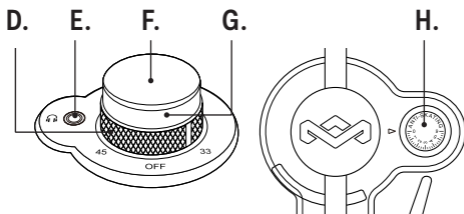
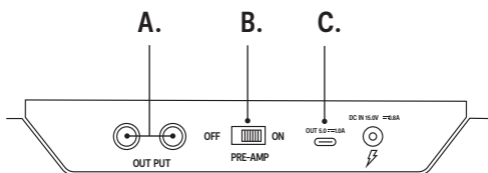

PRÉPARATION

INSTALLATION DE LA COURROIE D'ENTRAÎNEMENT

REMARQUE : La courroie d'entraînement est préinstallée sur l'appareil. Cependant, si vous ne voyez pas la courroie autour du sous-plateau et du moteur lorsque vous ouvrez le tourne-disque, veuillez la réinstaller.

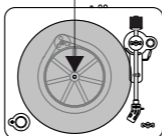
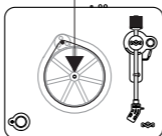
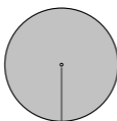
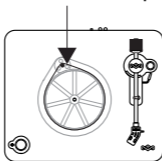

- Pour installer la courroie, placez-la sur le moteur (l'axe doré), puis tendez-la pour la faire passer autour du sous-plateau. Une fois qu'elle est en place, vérifiez que la courroie est bien à plat et qu'elle n'est pas tordue.
- Maintenant, placez le plateau en verre sur le sous-plateau noir, en alignant les trous centraux.
- Placez ensuite le tapis antidérapant REGRIND™ en liège sur le plateau en verre, toujours en alignant les trous centraux.

ÉQUILIBRAGE DU BRAS DE LECTURE

Option 1 (sans balance mécanique pour pointe de lecture):

- Poussez le contrepoids sur le bras de lecture jusqu'à entendre un clic.
- Retirez le couvercle de la pointe de lecture, avant d'essayer d'équilibrer le bras de lecture.
- Déclipsez le bras de lecture et assurez-vous qu'il flotte librement au-dessus de sa position de repos.
- Faites pivoter le contrepoids d'avant en arrière jusqu'à ce que le bras de lecture soit parallèle au plateau.

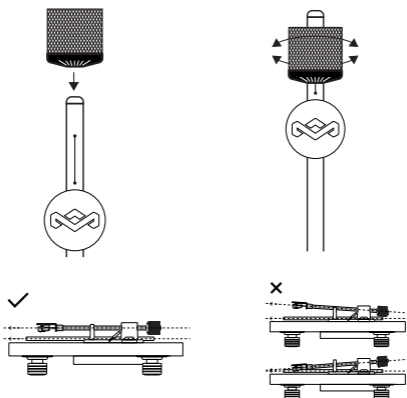

- Ensuite, remplacez le bras de lecture sur sa position de repos et clipsez-le pour le fixer. Ensuite, maintenez le contrepoids, de sorte qu'il ne bouge pas et, avec votre autre main, faites tourner le bouton avant jusqu'à ce qu'il indique 0. Votre bras de lecture est désormais mis à zéro.
- Maintenant, vous devez régler la force d'appui de la pointe de lecture. Pour cela, vous devez tourner l'ensemble du contrepoids dans le sens des aiguilles d'une montre, jusqu'à avoir ajouté le poids requis. La force d'appui pour cette pointe de lecture est comprise entre 1,5 g et 2,5 g (2,0 g de valeur standard)

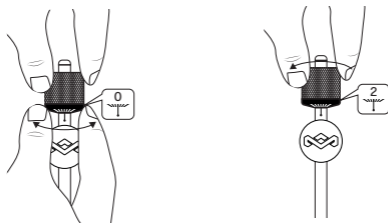

REMARQUE : Une fois l'opération terminée, si vous n'utilisez pas la platine pour écouter un disque, remplacez le couvercle sur la pointe de lecture pour la protéger lorsqu'elle n'est pas utilisée.

Option 2 (en utilisant la balance mécanique pour pointe de lecture):

- Poussez le contrepoids sur le bras de lecture jusqu'à entendre un clic.
- Retirez le couvercle de la pointe de lecture, avant d'essayer d'équilibrer le bras de lecture.
- Déclipsez le bras de lecture et assurez-vous qu'il flotte librement au-dessus de sa position de repos.
- Placez la balance mécanique pour pointe de lecture sur le plateau.
- Placez la pointe de lecture sur la marque des 2 grammes (force d'appui recommandée pour notre pointe de lecture).
- Faites pivoter le contrepoids d'avant en arrière jusqu'à ce que la balance mécanique soit au même niveau. Assurez-vous que la pointe de lecture reste bien sur la marque des 2 grammes.

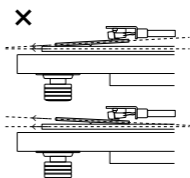
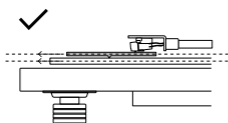
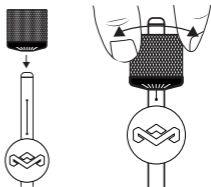
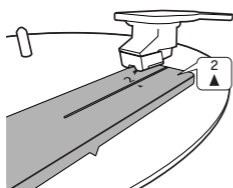

ANTI-PATINAGE

L'anti-patinage applique au bras de lecture une faible force centrifuge. Ainsi, la tendance du bras à se déplacer vers l'intérieur (patiner) vers le centre du disque est compensée, notamment lorsque le bras se rapproche du milieu du disque.

L'anti-patinage doit correspondre à la force d'appui appliquée. Ainsi, pour notre platine, réglez-le sur 2.

LECTURE D'UN DISQUE

1. Assurez-vous que le modèle Stir It Up Lux est branché à l'adaptateur secteur et à la prise murale et que celle-ci est alimentée.
2. Placez un disque vinyle sur le plateau.

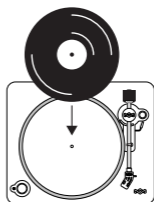
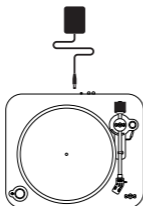

- Assurez-vous d'avoir retiré le couvercle de la pointe de lecture.
- Tournez le cadran « RPM » sur la vitesse adaptée au disque. Par exemple, 45 / 33

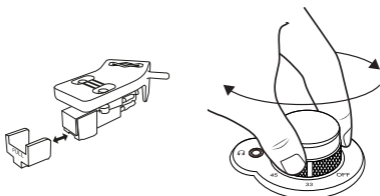

- Si vous souhaitez utiliser la platine via Bluetooth, veuillez vous reporter à la section « Appairage Bluetooth » et revenir à ce paragraphe une fois la platine connectée à un dispositif de sortie. Si vous souhaitez que le disque soit lu via une sortie câblée ou un casque, veuillez vous reporter aux sections expliquant comment connecter le dispositif de sortie. Revenez ensuite à cette section.

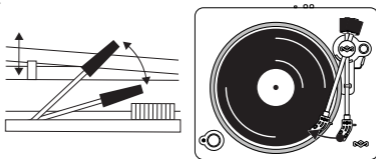

- Levez le bras de lecture à l'aide du levier de levage et déplacez la tête du bras de lecture vers le bord du disque.
- Abaissez maintenant le bras de lecture, en abaissant le levier de levage du bras de lecture.

REMARQUE : Le plateau de la platine commence à tourner automatiquement dès lors que le bras de lecture se trouve au-dessus du plateau.

- Une fois la lecture du disque terminée, le plateau de la platine s'arrête automatiquement. Levez le bras de lecture et placez-le sur sa position de repos. Pour écouter la face B de votre disque, retournez-le et répétez la procédure ci-dessus depuis l'étape 6.

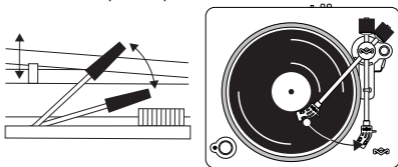

REMARQUE : Une fois la lecture du disque terminée, remettez le couvercle de la pointe de lecture afin de la protéger.

Ne tentez pas de régler le contrepois lorsqu'un disque est joué, car cela pourrait briser l'aiguille et rayer le disque.

Fixez le bras de lecture avant le transport pour protéger l'aiguille.

Retirez le contrepois avant le transport pour éviter d'endommager et de briser l'appareil.

N'arrêtez jamais et ne faites jamais tourner le plateau manuellement. Un déplacement ou un heurt de la platine lorsque le bras de lecture n'est pas fixé pourrait endommager ce dernier.

APPAIRAGE BLUETOOTH® (BT)

- Activez la fonction Bluetooth® de l'enceinte externe avant d'activer la fonction BT de la platine.
- Appuyez sur le bouton BT sur la platine (MFB), afin que le dispositif puisse rechercher l'appareil Bluetooth® jusqu'à ce que le témoin BT reste fixe. Ce témoin fixe indique que les deux appareils sont appariés.

REMARQUE : Si le tourne-disque ne s'appaire pas avec votre appareil Bluetooth® dans les 30 secondes, appuyez de nouveau sur le bouton de recherche Bluetooth® du tourne-disque. L'appairage devrait maintenant avoir lieu.

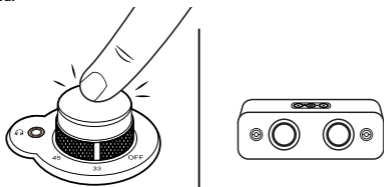

- Voyant à LED bleu clignotant
- Voyant à LED bleu stable

DÉSAPPAIRAGE BLUETOOTH® (BT)

Appuyez sur le bouton BT jusqu'à ce que le voyant BT s'éteigne. La platine se déconnecte de l'appareil externe.

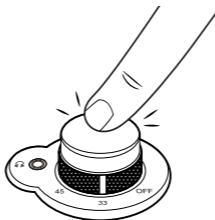

- Le témoin LED bleu devient rouge. Cela indique que la fonction Bluetooth est désactivée, mais la platine est toujours alimentée.

CONTRÔLE DU VOLUME

Augmentation du volume : Tournez le bouton du volume dans le sens des aiguilles d'une montre.

Réduction du volume : Tournez le bouton du volume dans le sens contraire des aiguilles d'une montre.

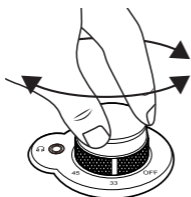

VOLUME +

VOLUME -

FONCTIONNEMENT DU CAQUE VIA LA PRISE CASQUE

Le témoin LED s'allume également en ROUGE fixe lorsque le casque est branché.

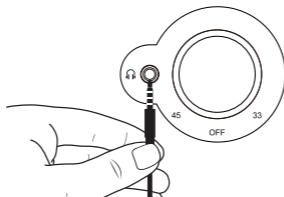

Remarque : Ne mettez jamais le casque sur la tête tant que le casque n'est pas branché dans la prise casque.

CONNEXION SANS BLUETOOTH®

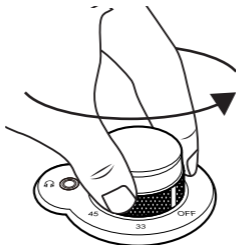

MISE EN GARDE: Coupez toute l'alimentation vers l'équipement avant de procéder aux connexions. Lisez les instructions de chaque composant que vous prévoyez d'utiliser avec cette platine. Veillez à bien brancher chaque fiche. Pour éviter les parasites et le bruit, évitez de regrouper les câbles d'interconnexion de signal avec le cordon d'alimentation secteur.

FONCTIONNEMENT DE LA SORTIE LIGNE RCA

1. Mettez l'INTERRUPTEUR MARCHE/ARRÊT DE PRÉAMPLIFICATION sur la position Marche.
2. Branchez une extrémité du câble RCA (inclus) dans la prise LINE OUT (Sortie) à l'arrière de l'appareil. Veillez à bien faire correspondre la couleur à la prise.
3. Branchez l'autre extrémité du câble dans la prise LINE IN (Entrée) de votre amplificateur.
4. Mettez l'appareil et l'amplificateur connecté en marche.
5. Réglez le volume sur l'amplificateur.

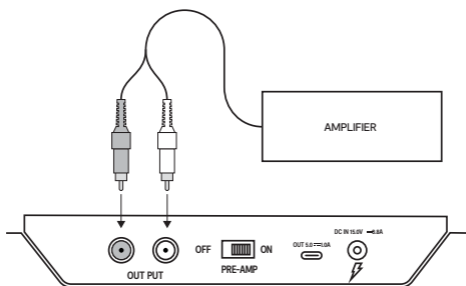

PORT DE SORTIE USB-C

Vous pouvez utiliser le port de sortie USB-C pour charger tous vos appareils ici. Nous vous recommandons de charger une enceinte House of Marley depuis ce port pour éviter l'utilisation d'adaptateurs.

ESPAÑOL

UBICACIÓN Y FUNCIONES DE LAS PARTES.

LEYENDA

- | | |
|---|------------------------------|
| A. Salida De Línea RCA | E. Conector Para Auriculares |
| B. Botón Interruptor Del Pre-Amplificador | F. Botón Bluetooth® |
| C. Salida USB-C | G. -Perilla - VOL + |
| D. Perilla De Apagado/33/45 | H. Perilla Anti-Patinaje |

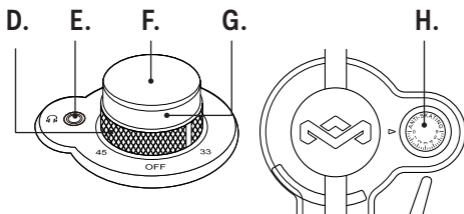
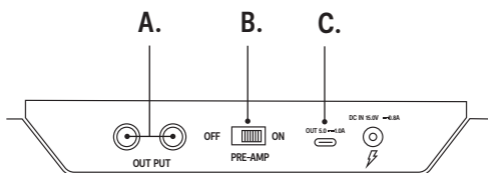

MAPA DE PRODUCTO

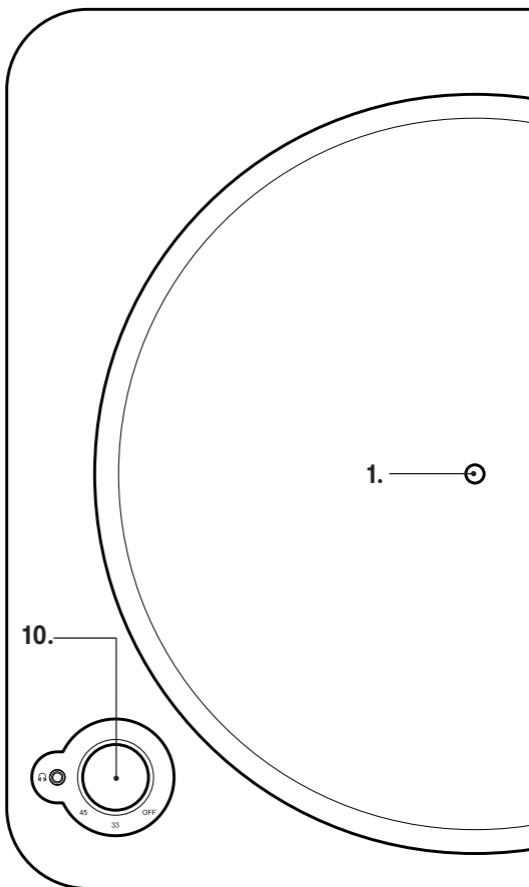

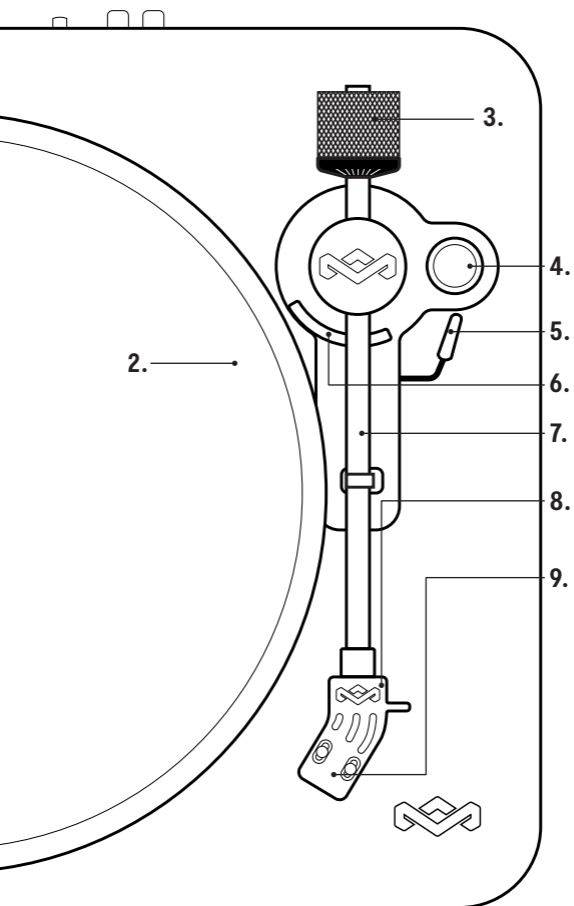

LEYENDA

1. Eje
2. Tocabdiscos
3. Contrapeso
4. Perilla Anti-Patinaje
5. Nivel De Elevación Del Brazo De Lectura
6. Soporte De Respaldo Del Brazo De Lectura
7. Brazo De Lectura
8. Aguja
9. Cubierta De La Aguja
10. Botón multifunción
11. Adaptador De Corriente Con 4 Enchufes Intercambiables
12. Adaptador De 45 Rpm
13. Calibrador de presión de aguja

11.

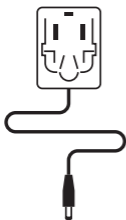

12.

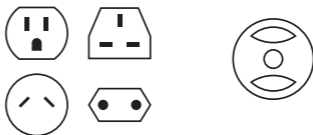

13.

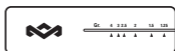

CONFIGURACIÓN

CÓMO SUJETAR LA CORREA DE TRANSMISIÓN

NOTA: La correa de transmisión viene preinstalada. Sin embargo, si al abrir el tocadiscos no se ve la correa alrededor del subplato y el motor, coloque la correa.

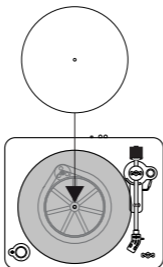
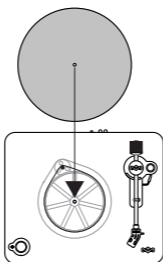
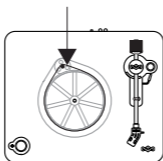

- Para montar la correa, sitúela sobre el motor (el eje dorado) y, sujetando la correa, estírela alrededor del subplato. Una vez colocada, asegúrese de que la correa está plana y no está torcida.
- Ahora, coloque el plato de cristal sobre el subplato negro, alineando los orificios centrales.
- A continuación, coloque la alfombrilla antideslizante de corcho REGRIND™ sobre el plato cristal alineando de nuevo los orificios centrales.

AJUSTAR EL BRAZO FONOCAPTOR

Opción 1 (sin calibrador de presión de aguja):

- Presione el contrapeso sobre el brazo hasta sentir un «clic».
- Quite la tapa de la aguja antes de intentar ajustar el brazo fonocaptor.
- Suelte el brazo fonocaptor del soporte y asegúrese de que se mantiene suspendido en el aire sin problema.
- Gire el contrapeso de un lado a otro hasta que el brazo quede paralelo al plato.

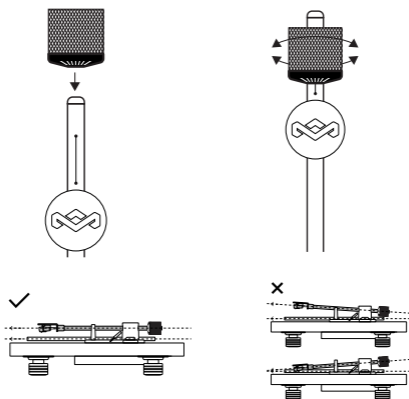

- A continuación, vuelva a colocar el brazo fonocaptor en el soporte e inserte la aguja en su sitio para que quede seguro. Luego, sujete el contrapeso para que no se mueva y, con la otra mano, gire el dial delantero hasta que esté en 0. El brazo fonocaptor está ahora en el valor 0.
- Ahora establezca la fuerza de seguimiento correcta para la aguja. Para ello, gire el contrapeso en sentido contrario a las agujas del reloj hasta que se encuentre en el peso correcto. La fuerza de seguimiento correcta para esta aguja es de entre 1,5 g y 2,5 g (2,0 g es la fuerza estándar)

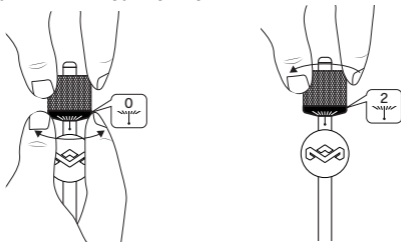

NOTA: Una vez que haya terminado, si no va a usar el tocadiscos, vuelva a colocar la tapa protectora de la aguja.

Opción 2 (con calibrador de presión de aguja):

- Presione el contrapeso sobre el brazo hasta sentir un «clic».
- Quite la tapa de la aguja antes de intentar ajustar el brazo fonocaptor.
- Suelte el brazo fonocaptor del soporte y asegúrese de que se mantiene suspendido en el aire sin problema.
- Coloque el calibrador de presión de aguja sobre el plato.
- Coloque la aguja sobre la marca de 2 gramos (fuerza de seguimiento recomendada para nuestra aguja).
- Gire el contrapeso de un lado a otro hasta que el calibrador de presión esté nivelado. Asegúrese de que la aguja se mantenga en la marca de 2 g.

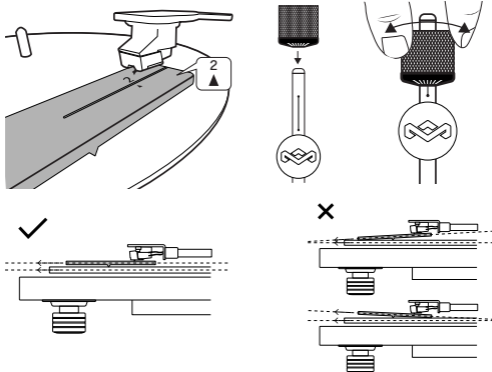

ANTI-PATINAJE

El anti-skate aplica una pequeña fuerza hacia fuera al brazo fonocaptor. Sirve para contrarrestar la tendencia del brazo a deslizarse hacia el centro del disco, especialmente cuando la grabación llega a la mitad.

El anti-skate debe coincidir con la fuerza de seguimiento establecida. Para nuestro tocadiscos, póngalo en el valor 2.

CÓMO TOCAR UN DISCO

1. Asegúrese de que el Stir It Up Lux esté conectado al adaptador de corriente y a una toma de corriente de pared, y que la toma esté encendida.
2. Coloque un vinilo en el tocadiscos.

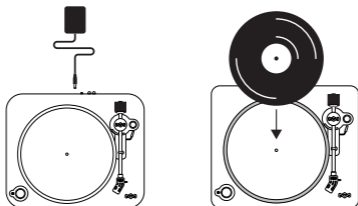

3. Asegúrese de que ha quitado la tapa protectora de la aguja.
4. Ajuste el dial a la velocidad correcta para el disco. Por ejemplo, entre los valores 45 y 33

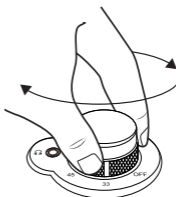
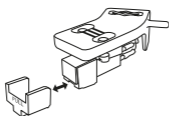

5. Si desea reproducirlo a través de Bluetooth, consulte la sección «Conexión por Bluetooth» y luego vuelva aquí una vez que esté conectado a cualquier dispositivo de salida. Si desea reproducirlo a través de una salida por cable o auriculares, consulte las secciones sobre cómo conectar el dispositivo de salida. Luego, vuelva a este paso.

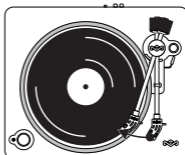
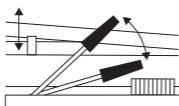

6. Levante el brazo fonocaptor mediante el elevador y mueva el cabezal del brazo fonocaptor hasta el borde del disco.
7. Ahora baje el brazo fonocaptor mediante el elevador del brazo fonocaptor.

NOTA: El plato del tocadiscos comenzará a girar automáticamente una vez que el brazo fonocaptor esté encima del plato.

8. Una vez que finaliza el disco, el plato se detendrá automáticamente. Levante el brazo fonocaptor y colóquelo en el soporte. Para escuchar la cara B de su disco, dele la vuelta al disco y repita todo lo anterior desde el paso 6.

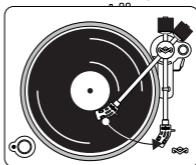
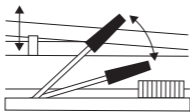

NOTA: Una vez que termine de escuchar un disco, asegúrese de volver a colocar la tapa protectora de la aguja.

Sostenga el brazo de lectura cada vez que realice cualquier ajuste o acción, de modo que se proteja el brazo de lectura.

No trate de ajustar el contrapeso mientras toca un disco, ya que esto podría romper la aguja y rayar el disco.

Vuelva a asegurar el brazo de lectura antes de transportar la unidad para proteger la aguja.

Retire el contrapeso antes de transportar la unidad para prevenir que ésta se dañe o rompa.

No detenga ni gire manualmente la base giratoria. Mover o sacudir el tocadiscos sin asegurar la pinza del brazo de lectura podría resultar en daños al brazo de lectura.

ACOPLAMIENTO BLUETOOTH®

- Encienda primero el dispositivo Bluetooth® externo antes de encender la función de BT del tocadiscos.
- Presione el botón BT en el tocadiscos (MFB) para permitir que la unidad busque el dispositivo Bluetooth® hasta que la luz indicadora de BT se vuelva fija. Esto indicará que sus dispositivos están conectados.

NOTA: Si el tocadiscos no se acopla con su dispositivo Bluetooth® dentro de 30 segundos, presione el botón de búsqueda Bluetooth® nuevamente en el tocadiscos y deberá acoplarse.

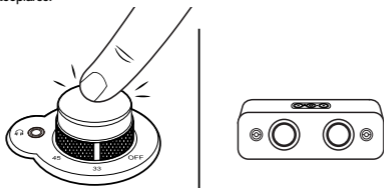

- Luz LED azul parpadeante
- Luz LED azul estable

CÓMO DESCONECTAR EL ACOPLAMIENTO BLUETOOTH®

Presione y mantenga presionado el botón BT hasta que se apague la luz indicadora BT. El tocadiscos se desconectará del dispositivo externo.

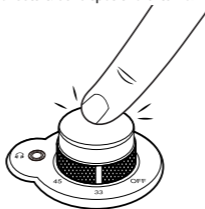

- La luz LED azul cambiará a rojo. Esto indica que Bluetooth está apagado, pero que el tocadiscos aún está conectado.

CONTROL DE VOLUMEN

Aumento de volumen: Gire la perilla de volumen según el sentido de las manecillas del reloj.

Disminución del volumen: Gire la perilla de volumen en sentido contrario a las manecillas del reloj.

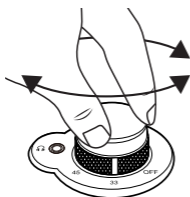

VOLUME +

VOLUME -

OPERACIÓN DE LOS AURICULARES A TRAVÉS DEL CONECTOR PARA AURICULARES

El LED también estará ROJO fijo cuando los auriculares estén conectados.

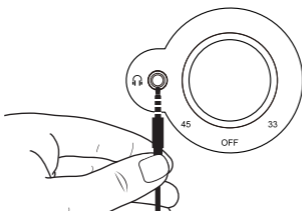

Nota: Nunca se coloque los auriculares hasta que haya conectado el enchufe de los auriculares

CONFIGURACIÓN DE LA CONEXIÓN SIN BLUETOOTH®

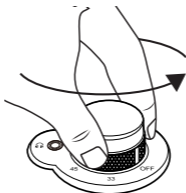

PRECAUCIÓN: Interrumpa la alimentación de todo el equipo antes de realizar cualquier conexión. Lea las instrucciones de cada componente que pretenda usar con esta unidad. Asegúrese de insertar cada enchufe en forma segura. Para prevenir algún zumbido o ruido, evite juntar los cables de interconexión de señal con el cable de alimentación de CA.

OPERACIÓN DE SALIDA DE LÍNEA

1. Coloque el INTERRUPTOR DE APAGADO/ENCENDIDO DEL PRE-AMPLIFICADOR en la posición de ENCENDIDO (ON).
2. Conecte un extremo del cable RCA (incluido) en el enchufe de SALIDA DE LÍNEA (LINE OUT) que está en la parte de atrás de la unidad. Asegúrese de que corresponda el color con el enchufe.
3. Conecte el otro extremo del cable en el enchufe de ENTRADA DE LÍNEA (LINE IN) de su dispositivo amplificador casero.
4. Encienda la unidad y el dispositivo amplificador que conectó.
5. Ajuste el volumen en el dispositivo amplificador.

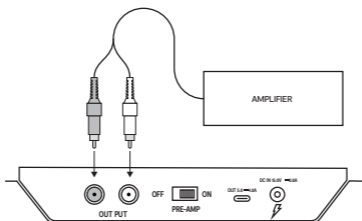

PUERTO DE SALIDA USB-C

Puede usar el puerto de salida USB-C para cargar cualquiera de nuestros dispositivos desde aquí. Recomendamos cargar un altavoz House of Marley desde aquí para dejar libres los adaptadores de corriente.

DEUTSCHE

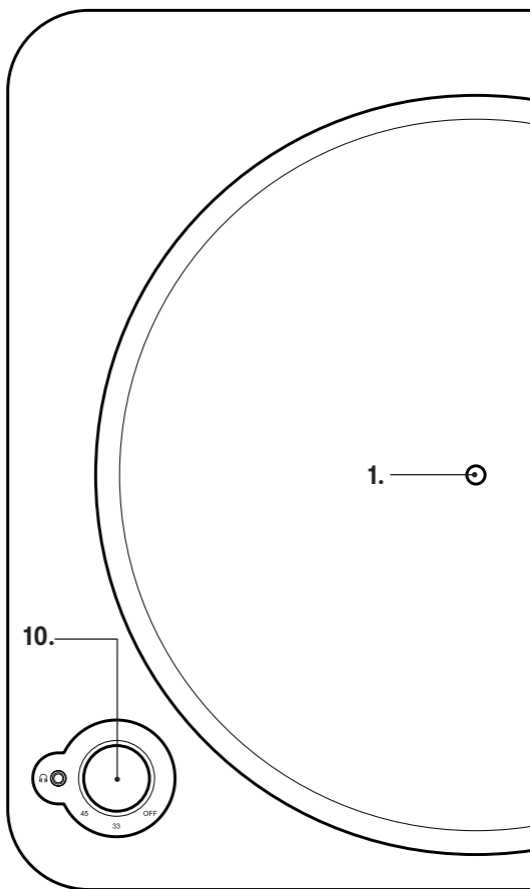

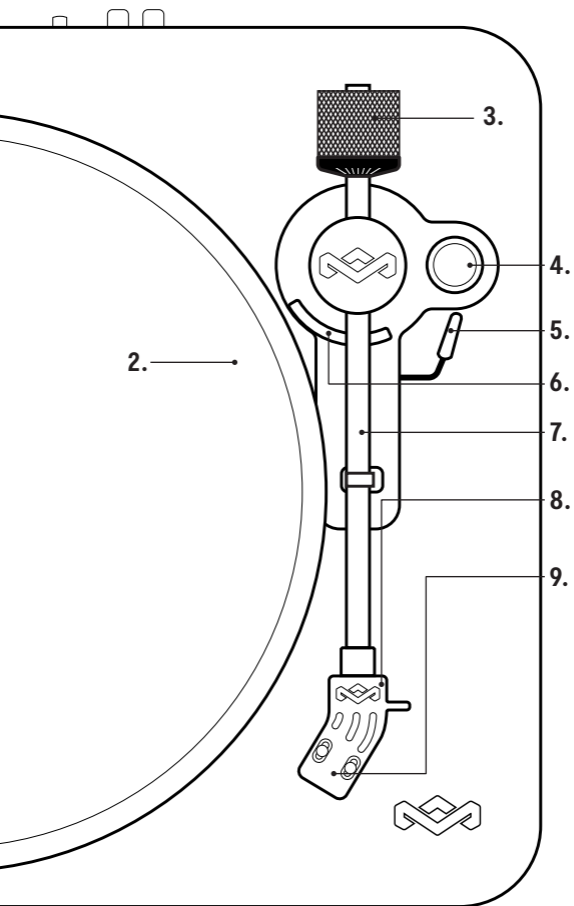

LEGENDE

1. Stift
2. Plattenspieler
3. Balancegewicht
4. Anti-Skating-Knopf
5. Tonarm-Heber
6. Tonarm-Aufnahme
7. Tonarm
8. Tonabnehmer
9. Nadelschutz
10. Multi-Function Button
11. Netzadapter mit 4 austauschbaren Steckern
12. 45 Adaptor
13. Tonarmwaage

11.

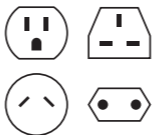
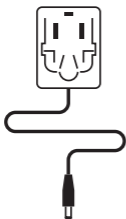

12.



13.

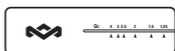

FUNKTIONS-LAYOUT

LEGENDE

- A. RCA-Ausgangsleitung
- B. Vorverstärker-Schalttaste
- C. USB-C-Ausgang
- D. Aus/33/45 Knopf
- E. Kopfhörerbuchse
- F. Bluetooth®-Taste
- G. - VOL + Knopf
- H. Anti-Skating-Knopf

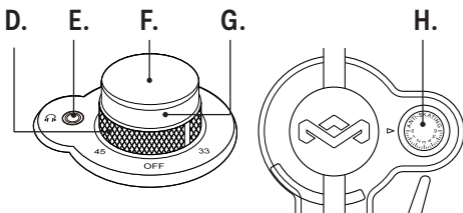
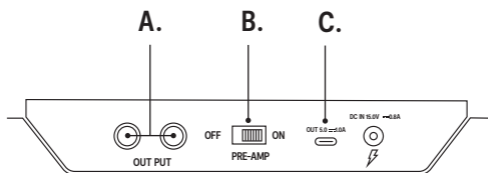

INSTALLATION

ANBRINGEN DES ANTRIEBSRIEMENS

Hinweis: Der Antriebsriemen ist bei Lieferung bereits installiert. Beim Öffnen des Plattenspielers ist der Riemen um Unterteller und Motor aber nicht sichtbar. Riemen bitte wieder anbringen.

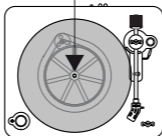
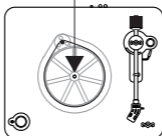
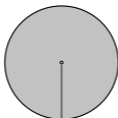
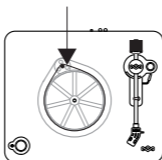

- Riemen zur Montage auf den Motor (das ist die goldene Spindel) legen und um den Unterteller spannen. Nachprüfen, ob er flach anliegt und nicht verdreht ist.
- Glasteller auf den schwarzen Unterteller legen (Mittellöcher ausrichten).
- REGRIND™ Korkleitmatte auf den Glasteller legen (Mittellöcher ausrichten).

EINSTELLUNG DES TONARMS

Option 1 (ohne Tonarmwaage):

- Ausgleichsgewicht am Tonarm verschieben, bis ein Klick zu spüren ist.
- Entfernen Sie die Nadelabdeckung, ehe Sie den Tonarm ausbalancieren.
- Lösen Sie den Tonarm von seiner Arretierung, sodass er sich frei bewegen lässt.
- Ausgleichsgewicht hin und her drehen, bis der Tonarm parallel zum Plattenteller ist.

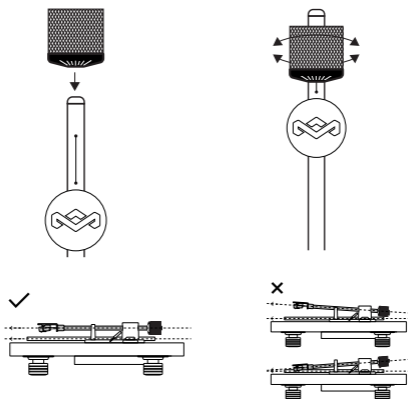

- Arretieren Sie jetzt den Tonarm wieder in seiner Ruheposition. Halten Sie das Gegengewicht, sodass es sich nicht bewegen kann, und drehen Sie mit der anderen Hand die vordere Drehscheibe auf 0. Jetzt ist Ihr Tonarm auf Null gesetzt.
- Jetzt braucht die Nadel noch die richtige Auflagekraft. Dazu drehen Sie das gesamte Gegengewicht gegen den Uhrzeigersinn, bis das richtige Gewicht aufliegt. Die richtige Auflagekraft für die Nadel ist 1,5-2,5 g (2,0 g sind Standard)

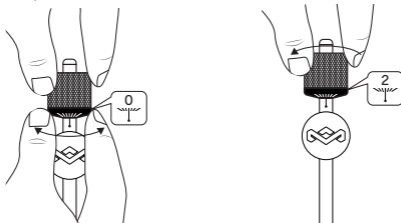

HINWEIS: Wenn Sie keine Platte abspielen möchten, bringen Sie nach dem Einstellen die Nadelabdeckung wieder an, um die Nadel während des Nichtgebrauchs zu schützen.

Option 2 (mit Tonarmwaage):

- Ausgleichsgewicht am Tonarm verschieben, bis ein Klick zu spüren ist.
- Entfernen Sie die Nadelabdeckung, ehe Sie den Tonarm ausbalancieren.
- Lösen Sie den Tonarm von seiner Arretierung, sodass er sich frei bewegen lässt.
- Tonarmwaage auf dem Plattenteller platzieren.
- Tonabnehmernadel auf der 2-Gramm-Marke platzieren (empfohlenes Auflagegewicht für die Tonabnehmernadel).
- Ausgleichsgewicht hin und her drehen, bis die Tonarmwaage waagrecht ist. Die Nadel muss bei der 2-g-Marke bleiben.

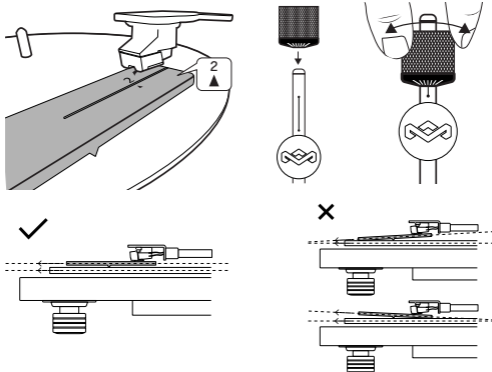

ANTI-SKATE

Anti-Skate besteht in einer leichten nach außen wirkenden Kraft auf den Tonarm. Diese wirkt entgegen des Tonarmzugs nach innen, in Richtung Plattenmitte (Skating), und zwar umso stärker, je näher zur Mitte er kommt.

Das Anti-Skate sollte auf die angewendete Auflagekraft abgestimmt sein. Stellen Sie sie für Ihren Plattenspieler deshalb auf 2.

SPIELN EINER SCHALLPLATTE

1. Verbinden Sie den Stir It Up Lux mit dem Netzadapter und einer funktionierenden Netzsteckdose.
2. Legen Sie eine Vinylplatte auf den Plattenteller.

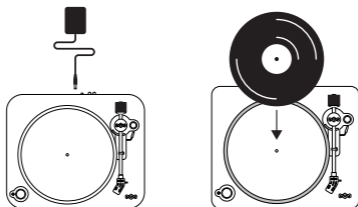

- Entfernen Sie die Nadelabdeckung.
- Drehen Sie die RPM-Auswahl auf die richtige Geschwindigkeit für die Platte – 45 oder 33

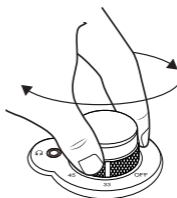
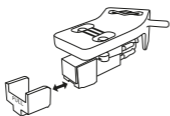

- Bluetooth: Siehe Abschnitt „Bluetooth-Kopplung“. Nach Verbindung eines Ausgangsgeräts wieder an diese Stelle zurückkommen. Kabel- oder Kopfhörerausgang: Siehe Abschnitte zur Verbindung von externen Geräten. Danach wieder an diese Stelle zurückkommen.

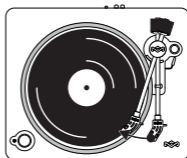
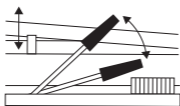

- Heben Sie den Tonarm mit Hilfe des Hebels an und bewegen Sie den Arm an den Rand der Platte.
- Senken Sie jetzt den Arm mit Hilfe des Hebels.

HINWEIS: Der Plattenteller beginnt sich automatisch zu drehen, sobald der Tonarm über der Platte steht.

- Wenn die Platte abgespielt ist, schaltet sich der Plattenteller automatisch wieder ab. Heben Sie den Tonarm und bringen Sie ihn in seine Ruheposition. Zum Hören der B-Seite drehen Sie die Platte um und wiederholen ab Schritt 6.

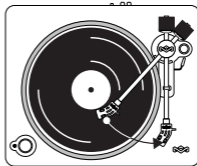
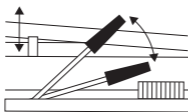

HINWEIS: Wenn Sie keine Platte mehr hören möchten, bringen Sie auf jeden Fall die Nadelabdeckung wieder an, um die Nadel zu schützen.

Bei Einstellungen den Tonarm festhalten, um diesen zu schützen.

Das Balancegewicht darf nicht verstellt werden, während eine Schallplatte abgespielt wird. Dabei könnte die Nadel abbrechen und die Schallplatte beschädigt werden.

Vor dem Transportieren den Tonarm feststellen, um die Nadel zu schützen.

Vor dem Transportieren das Balancegewicht abnehmen, um Schäden am Gerät zu vermeiden.

Den Plattenteller weder anhalten noch umdrehen. Bewegen oder Rütteln des Schallplattenspielers ohne Feststellen des Tonarms kann den Tonarm beschädigen.

BLUETOOTH®-KOPPLUNG

- Vor dem Einschalten der BT-Funktion am Schallplattenspieler das externe Bluetooth®-Gerät anschalten.
- Drücken Sie die BT-Taste am Plattenspieler (MFB), um nach einem Bluetooth®-Gerät zu suchen, bis das BT-Signallämpchen durchgehend leuchtet. Dies bedeutet, die Kopplung war erfolgreich.

HINWEIS: Falls sich der Plattenteller nicht innerhalb von 30 Sekunden mit Ihrem Bluetooth®-Gerät koppeln lässt, die Bluetooth®-Suchtaste auf dem Plattenteller nochmals drücken. Jetzt sollten die Geräte gekoppelt werden.

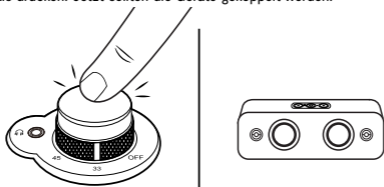

- Blaue LED-Leuchte blinkt
- Blaue LED-Leuchte leuchtet beständig

BLUETOOTH®-GERÄTE ENTKOPPELN

Die BT-Taste eine Zeit lang drücken, bis die BT-Anzeigeleuchte erlischt. Der Schallplattenspieler wird vom externen Gerät abgetrennt.

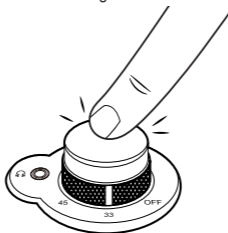

- Die blaue LED-Leuchte wird ausgeschaltet.

LAUTSTÄRKEREGLER

Lautstärke erhöhen: Den Lautstärkeknopf nach rechts drehen.

Lautstärke verringern: Den Lautstärkeknopf nach links drehen.

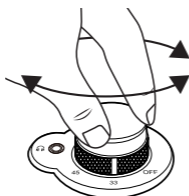

VOLUME +

VOLUME -

KOPFHÖRERBETRIEB ÜBER KOPFHÖRERBUCHSE

Das LED-Licht erscheint außerdem durchgehend rot, wenn Kopfhörer angeschlossen sind.

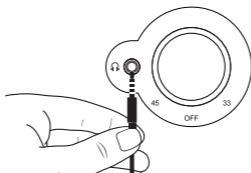

Hinweis: Niemals einen bereits an die Kopfhörerbuchse angeschlossenen Kopfhörer aufsetzen

Nota: Nunca se coloque los auriculares hasta que haya conectado el enchufe de los auriculares

EINRICHTUNG OHNE BLUETOOTH®-VERBINDUNG

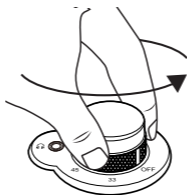

VORSICHT: Vor dem Anschließen alle Geräte ausschalten. Die Anleitungen für alle Komponenten, die Sie mit diesem Gerät benutzen möchten, durchlesen. Alle Stecker fest einstecken. Signalverbindungskabel dürfen sich nicht in der Nähe des AC-Stromkabels befinden, um Brummen und Rauschen zu vermeiden.

AUSGANGSLEITUNGS-BETRIEB

1. Den AUS-/EIN-SCHALTER FÜR DEN VORVERSTÄRKER (PRE-AMP OFF/ON SWITCH) auf EIN (ON) stellen.
2. Das eine Ende des RCA-Kabels (im Lieferumfang inbegriffen) in die AUSGANGSLEITUNG (LINE OUT) Buchse an der Rückseite des Geräts stecken. Die Farbe an der Buchse muss mit der Farbe am Kabel übereinstimmen.
3. Das andere Kabelende in die EINGANGSLEITUNG (LINE IN) Buchse Ihres Heimverstärkers stecken.
4. Das Gerät und den von Ihnen angeschlossenen Verstärker einschalten.
5. Die Lautstärke am Verstärker einstellen.

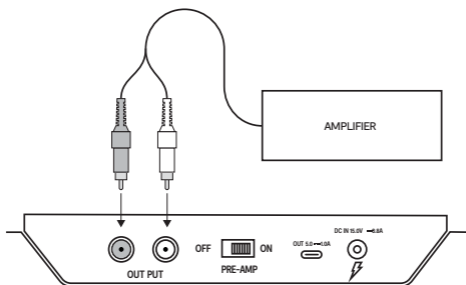

USB-C-AUSGANG:

Der USB-C-Ausgang kann zum Laden von Geräten verwendet werden. Es wird empfohlen, Lautsprecher von House of Marley damit zu laden, um Zwischenstecker zu sparen.

ITALIANO

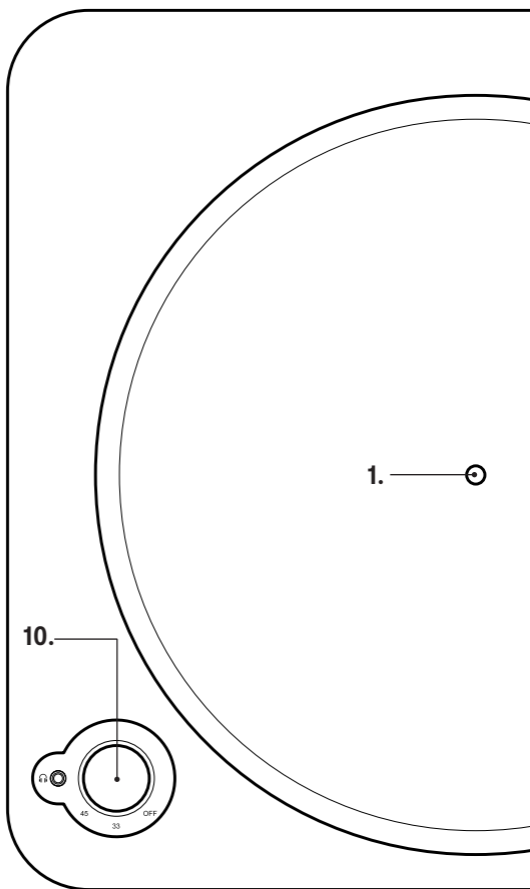

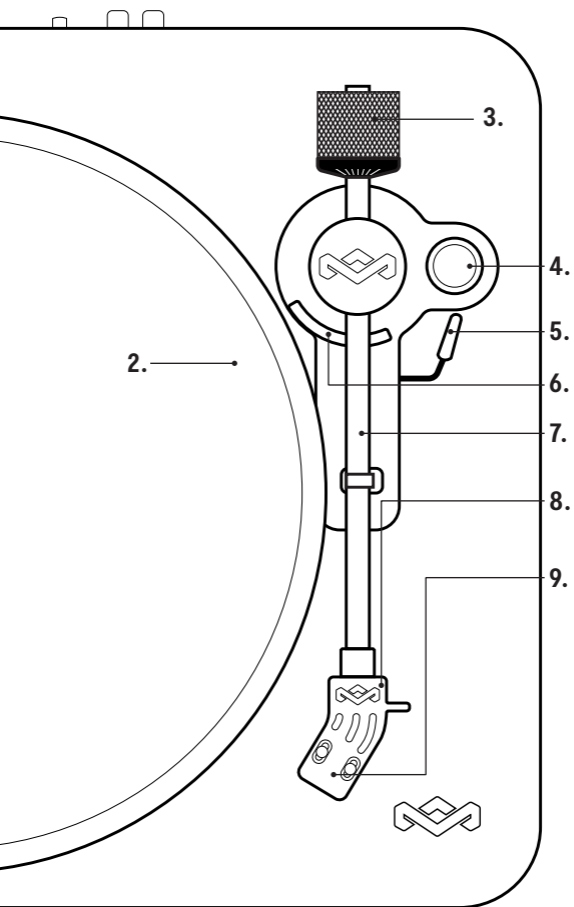

LEGENDA

1. Mandrino
2. Giradischi
3. Peso
4. Rotellina antiskate
5. Alzabraccio
6. Supporto braccio
7. Braccio
8. Stylus
9. Protezione ago
10. Pulsante multifunzione (MFB)
11. Adattatore alimentazione con 4 spine intercambiabili
12. Adattatore 45
13. Misuratore di forza della puntina

11.

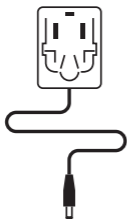

12.

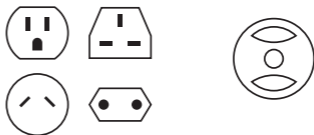

13.

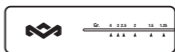

PRESENTAZIONE DELLE FUNZIONI

LEGENDA

- A. Linea In Uscita RCA
- B. Interruttore Preamplificatore
- C. Uscita USB-C
- D. Rotellina Disattivato/33/45
- E. Jack Cuffie
- F. Pulsante Bluetooth®
- G. - VOL + Rotellina
- H. Rotellina Antiskate

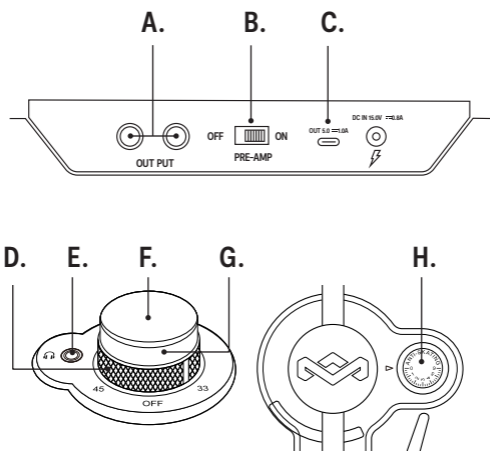

PREPARAZIONE

MONTAGGIO DELLA CINGHIA DI TRASMISSIONE

NOTA: La cinghia di trasmissione è preinstallata. Tuttavia, se al momento di aprire il giradischi non c'è nessuna cinghia visibile intorno al sottopiatto e al motorino, occorre rimontare la cinghia.

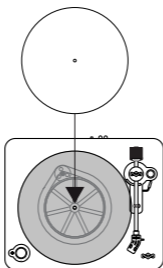
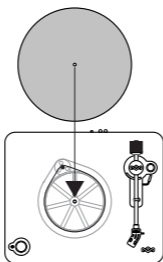
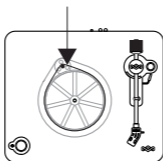

- Per sistemare la cinghia, applicatela sul motore (il perno dorato) e, tenendola ben tesa, fatela girare attorno al sottopiatto. Una volta posizionata, assicuratevi che la cinghia sia piatta e non attorcigliata.
- Ora posizionate il piatto di vetro sul sottopiatto nero, allineando gli appositi fori centrali.
- Posizionate ora il tappetino di sughero REGRIND™ sul piatto di vetro, allineando nuovamente i fori centrali.

BILANCIAMENTO DEL BRACCIO

Opzione 1 (senza misuratore di forza della puntina):

- Spingere il contrappeso sul braccio fino a sentire un clic.
- Rimuovere il coperchio della testina prima di tentare di bilanciare il braccio.
- Sganciare il braccio dal suo supporto e assicurarsi che fluttui liberamente.
- Ruotare il contrappeso avanti e indietro fino a quando il braccio non è parallelo al piatto.

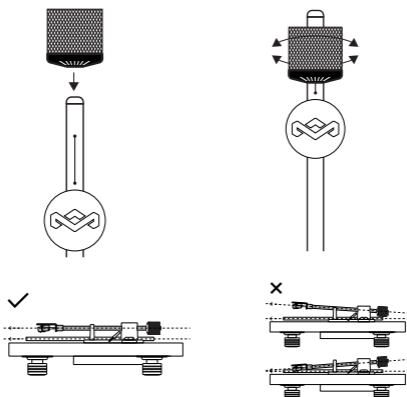

- Riposizionare il braccio nel suo alloggiamento e agganciarlo in modo che sia ben saldo. Ora tenere il contrappeso in modo che non possa muoversi e con l'altra mano ruotare il quadrante anteriore fino a portarlo a 0. Il braccio è ora azzerato.
- Ora è necessario aggiungere la pressione di lettura corretta per lo stilo. A questo scopo, ruotare l'intero peso del contrappeso in senso antiorario finché non viene aggiunto il peso corretto. La pressione di lettura corretta per questo stilo = 1,5g - 2,5g (2,0 g standard)

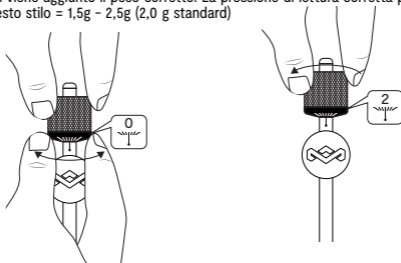

NOTA: Una volta terminato, se non si utilizza il giradischi per riprodurre un disco, rimettere il coperchio della testina dello stilo per proteggere lo stilo quando non viene utilizzato.

Opzione 2 (con misuratore di forza della puntina):

- Spingere il contrappeso sul braccio fino a sentire un clic.
- Rimuovere il coperchio della testina prima di tentare di bilanciare il braccio.
- Sganciare il braccio dal suo supporto e assicurarsi che fluttui liberamente.
- Posizionare il misuratore di forza della puntina sul piatto.
- Posizionare la puntina sulla tacca dei 2 grammi (forza di tracciamento consigliata per le nostre puntine).
- Ruotare il contrappeso avanti e indietro finché il misuratore di forza non è orizzontale. Assicurarsi che la puntina rimanga sulla tacca dei 2 grammi.

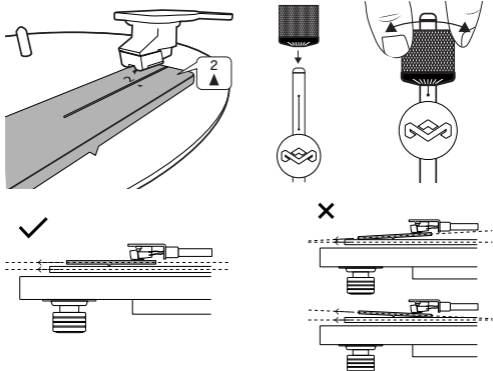

ANTI-SKATE

L'anti-skate applica una piccola forza verso l'esterno del braccio. Questo serve a contrastare la tendenza del braccio a spostarsi all'interno (skate) verso il centro del disco, soprattutto quando esso si avvicina al centro del disco.

L'anti-skate deve corrispondere alla pressione di lettura aggiunta. Per il nostro giradischi, impostare 2.

RIPRODUZIONE DI UN DISCO

1. Assicurarsi che Stir It Up Lux sia collegato all'adattatore di corrente e a una presa a muro e che la presa sia accesa.
2. Mettere un vinile sul giradischi.

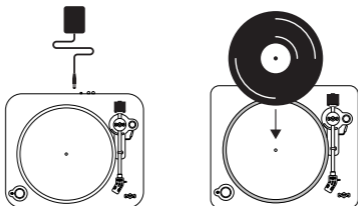

- Assicurarsi che il coperchio della testina dello stilo sia rimosso.
- Ruotare il selettore RPM sulla velocità corretta per il disco. Ad esempio 45 / 33

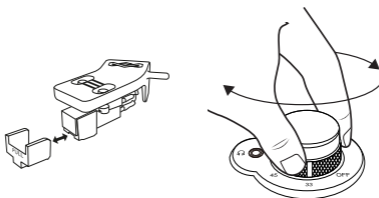

- Se si desidera riprodurre tramite Bluetooth, consultare la sezione "Bluetooth Pairing" e procedere una volta collegato a un dispositivo di uscita. Se si desidera riprodurre tramite l'uscita di linea o l'uscita cuffie, consultare le rispettive sezioni su come collegare il dispositivo di uscita. E poi procedere.

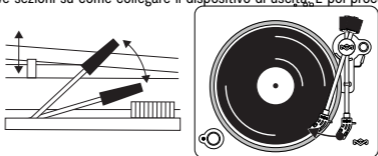

- Sollevare il braccio tramite il meccanismo di Cueing e spostare la testina sul bordo del disco.
- Ora abbassare il braccio, abbassando il meccanismo di Cueing del braccio.

NOTA: Il piatto del giradischi inizierà a girare automaticamente quando il braccio si troverà sopra il piatto.

- Una volta terminato il disco, il piatto del giradischi si arresterà automaticamente. Sollevare il braccio e posizionarlo sul supporto del braccio. Per ascoltare il lato B del disco, capovolgere il disco e ripetere le operazioni descritte al punto 6.

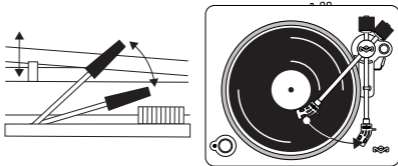

NOTA: Una volta terminato l'ascolto di un disco, accertarsi che il coperchio della testina dello stilo sia riattaccato per proteggere lo stilo.

Tenere il braccio ogni volta che si effettuano regolazioni o interventi per proteggerlo.

Non tentare di regolare il peso mentre si riproduce un disco per evitare di rompere l'ago e graffiare il disco.

Fissare il braccio prima del trasporto per proteggere l'ago.

Rimuovere il peso prima del trasporto per prevenire danni o la rottura dell'unità.

Non bloccare o girare manualmente il piatto. Se si sposta o scuote il giradischi senza aver fissato il morsetto del braccio si rischia di danneggiare il braccio

ASSOCIAZIONE BLUETOOTH®

- Attivare la funzione Bluetooth® dell'altoparlante esterno prima di attivare la funzione BT del giradischi.
- Premere il pulsante BT sul giradischi (MFB) per consentire all'unità di cercare il dispositivo Bluetooth® finché la spia BT non diventa fissa. Ciò indica che i dispositivi sono accoppiati.

NOTA: Se il Giradischi non si associa al dispositivo Bluetooth® entro 30 secondi, premere di nuovo il pulsante di ricerca Bluetooth® sul giradischi, e si dovrebbe associare.

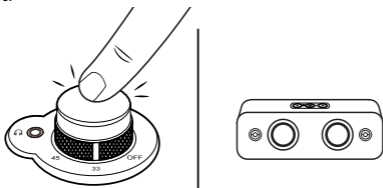

- Blue LED light flash
- Blue LED light stable

DISSOCIAZIONE BLUETOOTH®

Mantenere premuto il pulsante BT (MFB) fino a quando la spia BT non si spegne. A questo punto il giradischi si scollega dal dispositivo esterno.

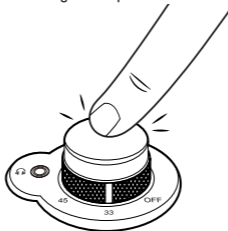

- La luce blu del LED diventa rossa. Ciò indica che il Bluetooth è disattivato, ma il giradischi è ancora alimentato.

REGOLAZIONE DEL VOLUME

Per alzare il volume: Ruotare in senso orario la rotellina del volume.

Per abbassare il volume: Ruotare in senso antiorario la rotellina del volume.

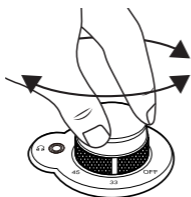

VOLUME +

VOLUME -

USO DELLE CUFFIE CON IL JACK APPOSITO

Il LED diventa ROSSO fisso anche quando le cuffie sono collegate.

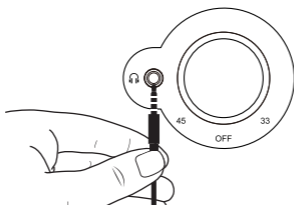

Nota: Mettersi le cuffie solamente dopo aver inserito la spina delle cuffie.

IMPOSTAZIONE DI UN COLLEGAMENTO NON BLUETOOTH®

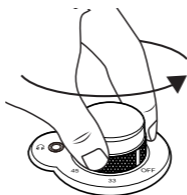

ATTENZIONE: Spegnerne tutti i dispositivi prima di eseguire i collegamenti. Leggere le istruzioni di ciascun componente che s'intende usare con questa unità. Inserire a fondo ogni spina. Per prevenire ronzio e rumore, evitare di raggruppare i cavi di interconnessione del segnale insieme al cavo di alimentazione.

USO DELLA LINEA IN USCITA

1. Collocare in posizione OFF L'INTERRUTTORE ON/OFF PREAMPLIFICATORE.
2. Inserire un'estremità del cavo RCA (in dotazione) nella presa LINE OUT sul retro dell'unità. Assicurarsi di abbinare il colore a quello della presa.
3. Inserire l'altra estremità del cavo nella presa LINE IN del dispositivo di amplificazione di casa.
4. Accendere l'unità e il dispositivo di amplificazione collegato.
5. Regolare il volume sul dispositivo di amplificazione.

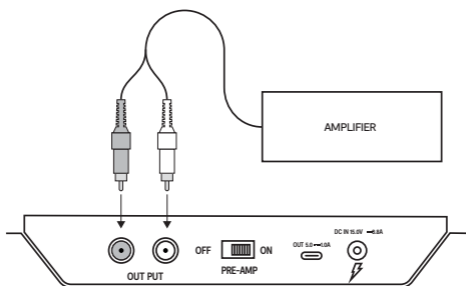

PORTA DI USCITA USB-C

È possibile utilizzare la porta di uscita USB-C per caricare qualsiasi dispositivo. Si consiglia di caricare un altoparlante House of Marley utilizzando questa porta per non dover acquistare un adattatore per la spina

NEDERLANDS

Voor vragen over uw House Of Marley draaitafel, scan de onderstaande QR Code



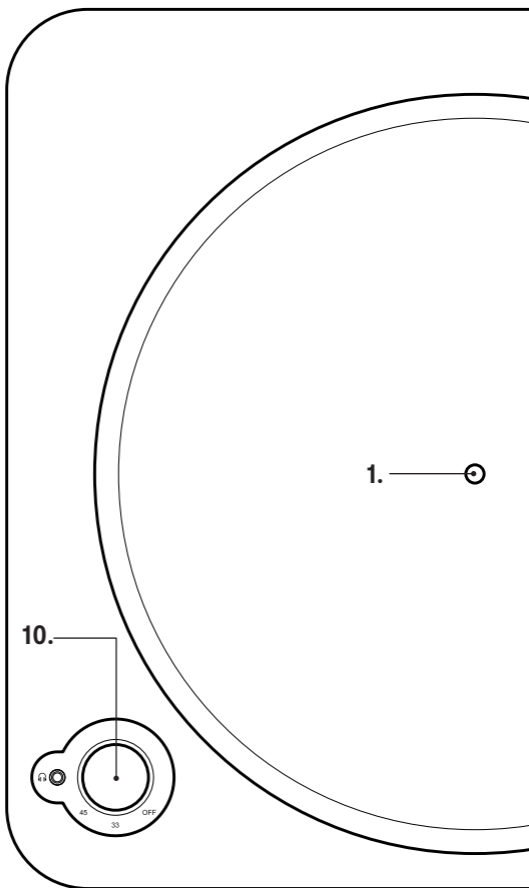

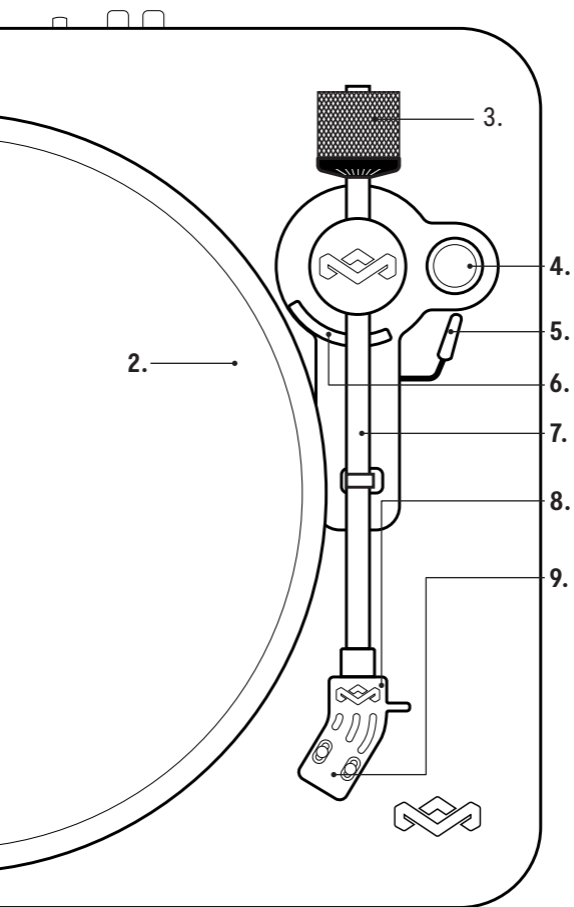

LEGENDA

1. As
2. Platenspeler
3. Contragewicht
4. Anti-skate knop
5. Toonarm omhoog/ omlaag
6. Ondersteuning toonarm lift
7. Toonarm
8. Stylus
9. Naald element houder
10. Multi-Functie knop
11. Voeding adapter met 4 verschillende wereld stekker adapters
12. 45 TPM Adapter
13. Stylusdrukmeter

11.

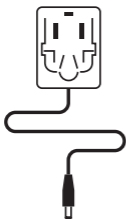

12.

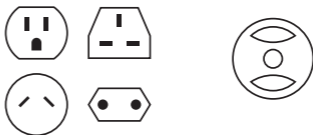

13.

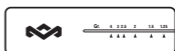

FUNCTIE-INDELING

LEGENDA

- A. RCA uit naar speaker
versterker
- B. Voorversterker UIT/AAN
- C. USB-C Uit
- D. UIT/AAN/33/45TPM
- E. Hoofdtelefoon
- F. Bluetooth® knop (MFB)
- G. VOLUME +/-
- H. Anti-skating knop

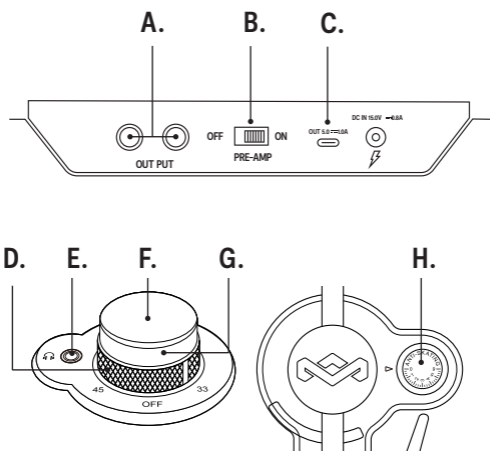

INSTELLEN

AANDRIJFRIEM PLAATSEN

OPMERKING: De aandrijfsnaar wordt vooraf geïnstalleerd. Is er rond het subplateau en de motor van de platenspeler bij openen echter geen aandrijfsnaar zichtbaar, plaats dan de aandrijfsnaar opnieuw.

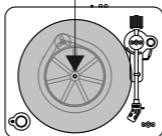
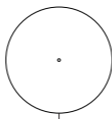
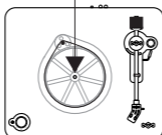
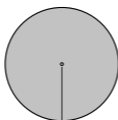
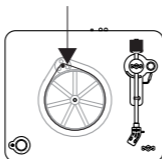

- Bevestig de aandrijfsnaar aan de motor (dat is de goudkleurige spoel) en houd de snaar vervolgens strak en trek rond het subplateau. Controleer na bevestiging of de snaar plat is en niet gedraaid.
- Plaats het metalen plateau nu op het zwarte subplateau door te zorgen dat de gaten in het midden op één lijn liggen.
- Plaats nu de siliconen REGRIND™-slipmat op het metalen plateau en zorg opnieuw dat de gaten in het midden op één lijn liggen.

DE TOONARM BALANCEREN

Optie 1 (zonder stylusdrukmeter):

- Druk op het contragewicht op de toonarm tot u een klik voelt.
- Verwijder eerst de stylusnaaldafdekking voordat u de toonarm probeert te balanceren.
- Haal de toonarm uit de klem en van de steun, en zorg ervoor dat deze vrij zweeft.
- Draai het contragewicht heen en weer totdat de toonarm evenwijdig is aan het plateau.

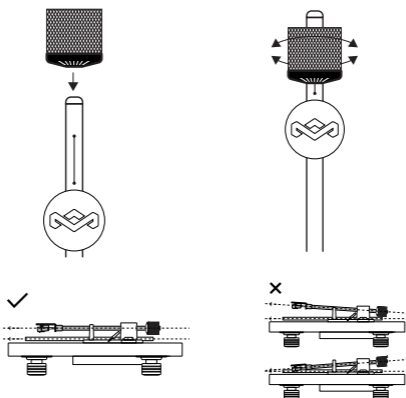

- Plaats de toonarm nu terug in de steun en klik hem goed vast. Houd het balansgewicht nu vast zodat het niet kan bewegen en draai de voorste draaiknop met uw andere hand naar 0. Uw toonarm is nu op nul gezet.
- Nu kunt u de juiste spoorkracht voor de stylus toevoegen. Dit doet u door het contragewicht met de klok mee te draaien totdat het juiste gewicht is toegevoegd. Het juiste gewicht voor deze stylus = 1,5 g – 2,5 g (2,0 g standaard)

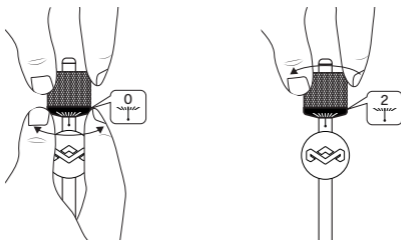

OPMERKING: Als u klaar bent en de draaitafel niet gebruikt om een plaat af te spelen, plaatst u de stylusnaaldafdekking terug om de stylus te beschermen wanneer deze niet in gebruik is.

Optie 2 (met stylusdrukmeter):

- Druk op het contragewicht op de toonarm tot u een klik voelt.
- Verwijder eerst de stylusnaaldafdekking voordat u de toonarm probeert te balanceren.
- Haal de toonarm uit de klem en van de steun, en zorg ervoor dat deze vrij zweeft.
- Plaats de stylusdrukmeter op het plateau.
- Plaats de stylus bij de markering '2 gram' (aanbevolen naalddruk voor onze stylus).
- Draai het contragewicht heen en weer totdat de drukmeter waterpas is. Zorg dat de naald blijft staan bij '2 gram'.

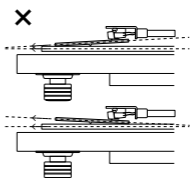
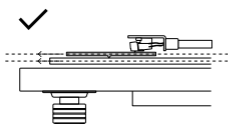
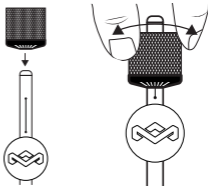
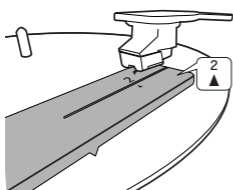

ANTI-SKATE

Anti-skate, oftewel dwarsdruk, oefent een kleine naar buiten gerichte kracht op de toonarm uit. Dit is om de binnenwaartse neiging van de arm (skate) richting het midden van de plaat tegen te gaan, met name wanneer de plaat het midden van de plaat nadert.

De Anti-Skate moet gelijk zijn aan de toegevoegde spoorkracht. Stel deze voor onze draaitafel dus in op 2.

EEN PLAAT AF SPELEN

1. Zorg ervoor dat de Stir It Up Lux is aangesloten op de voedingsadapter en een stopcontact, en dat het stopcontact is ingeschakeld.
2. Leg een plaat op de draaitafel.

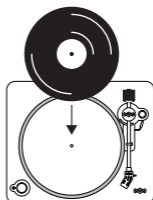
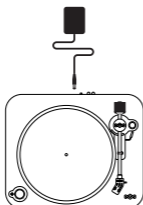

3. Verwijder de stylusnaaldafdekking.
4. Draai de toerenknop naar de juiste snelheid voor de plaat. Bijv. 45 / 33

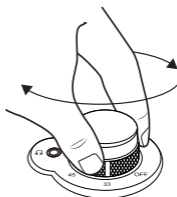
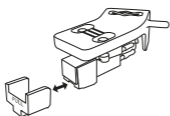

5. Als u via Bluetooth wilt afspelen – Raadpleeg dan het onderdeel 'Bluetooth-koppeling' en kom vervolgens hier terug nadat een uitvoerapparaat is gekoppeld. Als u via de lijnuitgang of de hoofdtelefoonuitgang wilt spelen – bekijk dan de secties over het aansluiten van het uitvoerapparaat. En kom daarna hier terug.

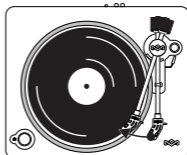
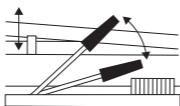

6. Til de toonarm op via de lifthendel en verplaats de toonarmkop naar de rand van de plaat.
7. Laat nu de toonarm zakken door de lifthendel van de toonarm te laten zakken.

OPMERKING: Zodra de toonarm zich boven het draaiplateau bevindt, begint deze automatisch te draaien.

8. Zodra de plaat klaar is, stopt het draaiplateau automatisch. Til de toonarm op en plaats deze op de toonarmsteun. Om naar de B-kant van uw plaat te luisteren, draait u de plaat om en herhaalt u de bovenstaande instructies vanaf stap 6.

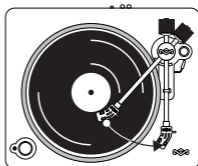
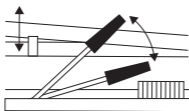

OPMERKING: Als u klaar bent met het beluisteren van een plaat, plaats dan de stylusnaaldafdekking terug om de stylus te beschermen.

Verwijder het plastic bescherm kapje van de naald voordat je de naalddruk gaat afstellen.

Verander de naalddruk of antiskating NIET tijdens het afspelen van een plaat, dit kan de plaat beschadigen.

Tijdens transport: vergrendel de toonarm om de naald te beschermen tegen beschadiging. Verwijder het contragewicht, verwijder het plateau, plaats het beschermkapje over de naald.

Niet het draaiplateau handmatig tegenhouden of draaien.

BLUETOOTH® VERBINDING

- LET OP DAT ER ZICH GEEN ANDERE APPARATEN IN PAIRING MODE BEVINDEN (de Stir It Up Lux koppelt met de 1e in de buurt)
- Zet EERST het apparaat aan waarop je de muziek wilt weergeven EN ZET DEZE IN PAIRING MODE.
- Druk op de BT-knop op de draaitafel (MFB) om het apparaat naar het Bluetooth®-apparaat te laten zoeken totdat het BT-lampje ononderbroken brandt. Dit geeft aan dat uw apparaten zijn gekoppeld.

NB: Als de draaitafel niet binnen 30sec verbinding heeft met je Bluetooth® apparaat, druk dan nogmaals op de MFB knop, en wacht tot de verbinding tot stand is gekomen.

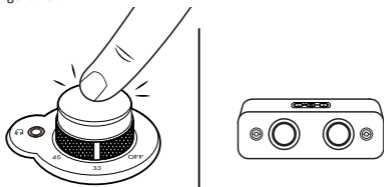

- Blauwe LED knippert, draaitafel in pairmode
- Blauwe LED brandt constant, er is een bluetooth koppeling met een apparaat
- Indien LED rood brandt is de koppeling mislukt of verbroken

ONTKOPPELEN BLUETOOTH® VERBINDING

Houdt de BT knop ingedrukt totdat de LED ROOD, je Stir It Up wordt ontkoppelt van je speaker.

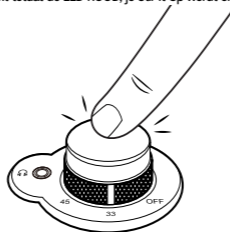

- Indien de blauwe LED, rood wordt, geeft dit aan dat Bluetooth is uitgeschakeld maar de draaitafel nog steeds aan staat.

VOLUME REGELING

Het volume van de hoofdtelefoon en de Bluetooth verbinding kan ingesteld worden met de draaiknop.

Volume verhogen: draai de volumeknop rechtsom. Volume verlagen: draai de volumeknop linksom.

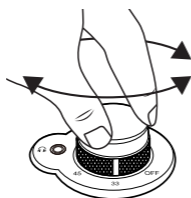

VOLUME +

VOLUME -

HOOFDTELEFOON AANSLUITING

Het led-lampje brandt ook ononderbroken ROOD wanneer de hoofdtelefoon is aangesloten.

Noot: EERST de hoofdtelefoon aansluiten en DAN PAS OPZETTEN ivm onverwacht volume.

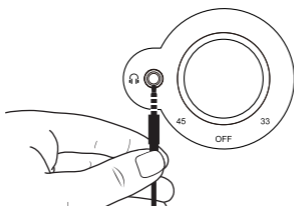

LIJN UITGANG AANSLUITING

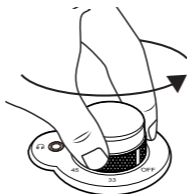

Indien je geen gebruik maakt van Bluetooth, kan je de Stir It Up Lux via de lijnuitgang, bedraad, aansluiten.

LET OP: Schakel alle stroom uit van de aan te sluiten apparaten. Raadpleeg de gebruiksaanwijzing van de apparaten voor verdere uitleg. Druk alle stekkers goed aan in de verbindingen zonder deze te forceren.

LINE OUT AANSLUITEN

Met bijgeleverde kabel RCA > 3,5 mm kan de draaitafel op de meeste draagbare speakers worden aangesloten. Een huiskamer versterker kan een optionele RCA > RCA kabel nodig hebben.

1.Zet de PRE-AMP OFF/ON Schakelaar naar de ON positie. 2.Sluit de RCA kabel rood/wit aan op de LINE OUTPUT

van de draaitafel.

3.Sluit de 3.5 mm kabel aan op de line in van de draagbare speaker of op de huiskamer versterker.

4.Zet de draaitafel aan en het aangesloten apparaat. 5.Stel het volume in op de speaker/versterker.

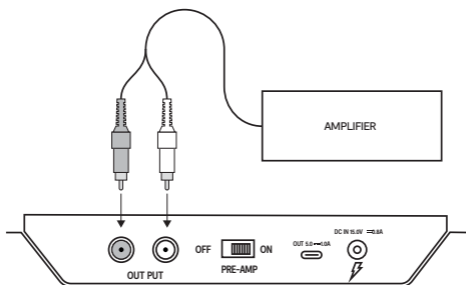

USB-C-UITGANG

U kunt de USB-C-uitgang gebruiken om uw apparaten op te laden. We raden aan om een House of Marley Speaker op te laden om de hoeveelheid verlengsnoeren te beperken.

Compliance Info ✓

Conformité / Conformidad / Beachtung / Conformità / Nalevingsinformatie / 合規情報 / 규정 준수 정보 / コンプライアンス情報

STIR IT UP LUX

READ ALL INSTRUCTIONS BEFORE USE AND SAVE THESE INSTRUCTIONS FOR FUTURE REFERENCE.

This equipment has been tested and found to comply with the limits for a Class B digital device, pursuant to part 15 of the FCC Rules. These limits are designed to provide reasonable protection against harmful interference in a residential installation. This equipment generates uses and can radiate radio frequency energy and, if not installed and used in accordance with the instructions, may cause harmful interference to radio communications. However, there is no guarantee that interference will not occur in a particular installation. If this equipment does cause harmful interference to radio or television reception, which can be determined by turning the equipment off and on, the user is encouraged to try to correct the interference by one or more of the following measures:

- Reorient or relocate the receiving antenna.
- Increase the separation between the equipment and receiver.
- Connect the equipment into an outlet on a circuit different from that to which the receiver is connected.
- Consult the dealer or an experienced radio/TV technician for help.

This device complies with FCC radiation exposure limits set forth for an uncontrolled environment.

This device complies with Part 15 of the FCC Rules. Operation is subject to the following two conditions: (1) this device may not cause harmful interference, and (2) this device must accept any interference received, including interference that may cause undesired operation.

FCC RF EXPOSURE STATEMENT:

This transmitter must not be co-located or operating in conjunction with any other antenna or transmitter.

CAUTION!

Any changes or modifications not expressly approved by the party responsible for compliance could void the user's authority to operate the equipment. To Maintain compliance with the FCC's RF exposure guidelines, place the product at least 20cm from nearby persons.

ISED STATEMENT

This device complies with Innovation, Science, and Economic Development Canada license-exempt RSS standard(s). Operation is subject to the following two conditions: (1) this device may not cause interference, and (2) this device must accept any interference, including interference that may cause undesired operation of the device.

Le présent appareil est conforme aux CNR d'Innovation, Sciences et Développement économique Canada applicables aux appareils radio exempts de licence. L'exploitation est autorisée aux deux conditions suivantes : (1) l'appareil ne doit pas produire de brouillage, et (2) l'utilisateur de l'appareil doit accepter tout brouillage radioélectrique subi, même si le brouillage est susceptible d'en compromettre le fonctionnement.

The device complies with RF exposure guidelines, users can obtain Canadian information on RF exposure and compliance.

Les utilisateurs peuvent sur l'exposition aux radiofréquences et la conformité and compliance d'acquérir les informations correspondantes. Utilisateurs peut obtenir l'information canadienne sur l'exposition et la conformité de rf.

The device should be installed and operated with a minimum distance of 20cm between the radiator and your body.

L'appareil doit être installé et utilisé avec une distance minimale de 20 cm entre le radiate et votre corps.

This Class B digital apparatus complies with Canadian ICES-003.

Cet appareil numérique de classe b est conforme à la norme nmb - 003 du canada.

ISED RF EXPOSURE STATEMENT:

The device is compliance with RF exposure guidelines, users can obtain Canadian information on RF exposure and compliance.

LE PRÉSENT APPAREIL EST CONFORME

Après examen de ce matériel aux conformités ou aux limites d'intensité de champ RF, les utilisateurs peuvent sur l'exposition aux radiofréquences et la conformité and compliance d'acquiescer. les informations correspondantes.

WEEE EXPLANATION

 This marking indicates that this product should not be disposed with other household wastes throughout the EU. To prevent possible harm to the environment or human health from uncontrolled waste disposal, recycle it responsibly to promote the sustainable reuse of material resources.

Hereby, FKA Brands Ltd, declares that this radio equipment is in compliance with the essential requirements and other relevant provisions of Directive 2014/53/EU. A copy of the Declaration of Conformity can be obtained from www.thehouseofmarley.co.uk/declaration-of-conformity

FR STIR IT UP LUX

LIRE TOUTES LES INSTRUCTIONS AVANT UTILISATION. LES CONSERVER POUR POUVOIR LES CONSULTER ULTÉRIEUREMENT.

EXPLICATION WEEE

 Le symbole indique que le produit ne doit pas être éliminé avec les autres déchets ménagers dans toute l'Union Européenne. L'élimination incontrôlée des déchets pouvant porter préjudice à l'environnement ou à la santé humaine, veuillez le recycler de façon responsable. Vous favoriserez ainsi la réutilisation durable des ressources matérielles.

FKA Brands Ltd déclare par la présente que cet équipement radio est conforme aux exigences essentielles et autres dispositions pertinentes de la Directive 2014/53/EU. Pour obtenir un exemplaire de la Déclaration de conformité, s'adresser à www.thehouseofmarley.co.uk/declaration-of-conformity

NL STIR IT UP LUX

ALLE INSTRUCTIES LEZEN ALVORENS HET PRODUCT IN GEBRUIK TE NEMEN. DEZE INSTRUCTIES ZORGVULDIG BEWAREN.

UITLEG OVER AEEA

 Deze markering geeft aan dat dit product binnen de EU niet met ander huisvuil mag worden weggeworpen. Om eventuele schade aan het milieu of de menselijke gezondheid door het ongecontroleerd wegwerpen van afval te voorkomen, dient dit apparaat op verantwoorde wijze gerecycled te worden om duurzaam hergebruik van materiaalbronnen te bevorderen.

Hierbij verklaart FKA Brands Ltd, dat deze radioapparatuur voldoet aan de essentiële vereisten en andere relevante voorschriften van Directive 2014/53/EU. Een kopie van de conformiteitsverklaring kan worden verkregen via

www.thehouseofmarley.co.uk/declaration-of-conformity

IT STIR IT UP LUX

LEGGERE INTEGRALMENTE LE PRESENTI ISTRUZIONI PRIMA DELL'USO. CONSERVARE LE PRESENTI ISTRUZIONI PER CONSULTAZIONI SUCCESSIVE.

SPIEGAZIONE DIRETTIVA RAEE

 Questo simbolo indica che il prodotto non deve essere smaltito assieme agli altri rifiuti domestici in tutti i Paesi dell'Unione Europea. Al fine di evitare un eventuale danno ambientale e alla salute umana derivante dallo smaltimento dei rifiuti non controllato, riciclare il prodotto in maniera responsabile per promuovere il riutilizzo sostenibile delle risorse materiali.

Con la presente, FKA Brands Ltd dichiara che l'apparecchiatura radio in oggetto è conforme ai requisiti essenziali e ad altre disposizioni pertinenti della Direttiva 2014/53/EU. È possibile richiedere una copia della Dichiarazione di conformità scrivendo all'indirizzo www.thehouseofmarley.co.uk/declaration-of-conformity

SP STIR IT UP LUX

LEA TODAS LAS INSTRUCCIONES ANTES DE USAR. GUARDE ESTAS INSTRUCCIONES PARA REFERENCIA FUTURA.

EXPLICACIÓN RAEI

 Este símbolo indica que este artículo no se debe tirar a la basura con otros residuos domésticos en ningún lugar de la UE. A fin de prevenir los efectos perjudiciales que la eliminación sin control de los residuos puede tener sobre el medio ambiente o la salud de las personas, le rogamos que los recicle de forma responsable para fomentar la reutilización sostenible de los recursos materiales.

Por la presente, FKA Brands Ltd declara que este dispositivo de radio está en conformidad con los requisitos esenciales y otras disposiciones relevantes de la directiva 2014/53/EU. Si desea una copia de la declaración de conformidad, solicítela a www.thehouseofmarley.co.uk/declaration-of-conformity

FIN STIR IT UP LUX

LUE KAIKKI OHJEET ENNEN KÄYTTÖÄ. SÄILYÄ NÄMÄ OHJEET TULEVAA TARVETTA VARTEN. TÄRKEÄT VAROTOIMENPITEET:

WEEE-SELITYS

 Tämä merkki tarkoittaa, että tätä tuotetta ei saa hävittää muiden talousjätteiden mukana missään EU-maassa. Kontrollioimattomasta jätteiden hävittämisestä mahdollisesti aiheutuvien ympäristöhaittojen tai terveysvaarojen estämiseksi hävitä tämä tuote vastuullisesti edistääksesi materiaalivarojen uudelleenkäyttöä.

FKA Brands Ltd. vakuuttaa, että tämä radiolaitte on direktiivin 2014/53/EU vaatimusten ja muiden siihen liittyvien säädösten mukainen. Kopion vaatimustenmukaisuusvakuutuksesta voi tilata lähettämällä sähköpostia osoitteeseen www.thehouseofmarley.co.uk/declaration-of-conformity

DE STIR IT UP LUX

LESEN SIE SICH VOR DER BENUTZUNG ALLE HINWEISE GUT DURCH. BEWAHREN SIE DIESE HINWEISE GUT AUF.

WEEE-ERKLÄRUNG

 Diese Kennzeichnung weist darauf hin, dass dieses Produkt innerhalb der EU nicht mit anderem Hausmüll entsorgt werden soll. Damit durch unkontrollierte Abfallentsorgung verursachte mögliche Umwelt- oder Gesundheitsschäden verhindert werden können, entsorgen Sie dieses Produkt bitte ordnungsgemäß und fördern Sie damit eine nachhaltige Wiederverwendung der Rohstoffe.

Hiermit erklärt die FKA Brands Ltd., dass dieses Funkgerät in Übereinstimmung mit den wesentlichen Anforderungen und anderen entsprechenden Bestimmungen der Richtlinie 2014/53/EU geliefert wird. Eine Kopie der Konformitätserklärung ist über www.thehouseofmarley.co.uk/declaration-of-conformity

TR STIR IT UP LUX

KULLANMADAN ÖNCE TÜM TALİMATLARI OKUYUN. BU TALİMATLARI DAHA SONRA BAŞVURMAK ÜZERE SAK.

WEEE AÇIKLAMASI

 Bu işaret bu ürünün AB genelinde diğer ev atıklarıyla birlikte atılmaması gerektiğini belirtir. Kontrolsüz atığın çevre veya insan sağlığına olası zararları engellemek için sorumlu bir şekilde geri dönüştürülmesini ve malzeme kaynaklarının sürdürülebilir şekilde yeniden kullanılmasını sağlayın.

İş bu vesileyle, FKA Brands Ltd, bu telsiz ekipmanının 2014/53/EU Yönergesinin temel gereksinimleri ve diğer ilgili hükümleriyle uyumlu olduğunu beyan eder. Uygunluk Beyanı'nın bir kopyası

www.thehouseofmarley.co.uk/declaration-of-conformity

SV STIR IT UP LUX

LÄS DESSA INSTRUKTIONER OCH BEHÅLL DEM FÖR ENKEL REFERENS.

LÄS ALLA INSTRUKTIONERNA FÖRE ANVÄNDNING. SPARA DESSA INSTRUKTIONER FÖR FRAMTIDA REFERENS.

WEEE-FÖRKLARING

 Denna markering indikerar att denna produkt inte får avyttras med annat hushållsavfall inom EU. För att förhindra möjlig skada på miljö eller person från okontrollerat avfallsavyttrande, återvinna på ansvarsfullt vis för att främja det fortsatta återanvändandet av materialresurser.

Härmed deklarerar FKA Brands Ltd att denna radioutrustning är förenlig med nödvändiga krav och andra relevanta bestämmelser i direktivet 2014/53/EU. En kopia av förenlighetsdeklarationen kan erhållas från www.thehouseofmarley.co.uk/declaration-of-conformity

RU STIR IT UP LUX

ПРОЧИТАЙТЕ ВСЕ ИНСТРУКЦИИ ПЕРЕД ИСПОЛЬЗОВАНИЕМ. СОХРАНИТЕ ЭТИ ИНСТРУКЦИИ ДЛЯ ДАЛЬНЕЙШЕГО ИСПОЛЬЗОВАНИЯ.

ЗАМЕНА БАТАРЕЙКИ

Динамик Stir It Up Wireless содержит аккумулятор, срок службы которого соответствует сроку службы продукта. Если возникнет необходимость в замене аккумулятора, что маловероятно, обратитесь в службу поддержки. Ее персонал предоставляет гарантийное обслуживание и осуществляет замену аккумуляторов (на замену аккумуляторов действие гарантии не распространяется).

ИНСТРУКЦИИ К БАТАРЕЯМ

 Данный символ означает, что батареи не следует утилизировать совместно с бытовым мусором, поскольку они содержат вещества, способные нанести вред окружающей среде и здоровью. Утилизируйте батареи в специально предназначенных для этого приемных пунктах.

ПОЯСНЕНИЕ WEEE

 Данная маркировка означает, что в странах Европы не допускается утилизировать прибор вместе с другими бытовыми отходами. Чтобы не нанести ущерба окружающей среде и здоровью населения в результате неверной утилизации отходов, прибор следует сдать на переработку, чтобы обеспечить экологичное повторное использование материальных ресурсов. Компания FKA Brands Ltd настоящим подтверждает соответствие данного радиооборудования основным требованиям и другим применимым положениям Директивы 2014/53/EU. Копия Декларации соответствия можно получить по электронному адресу:

www.thehouseofmarley.co.uk/declaration-of-conformity

DK STIR IT UP LUX

LÆS HELE VEJLEDNINGEN IGENNEM FØR BRUG. GEM DENNE VEJLEDNING TIL SENERE BRUG.

WEEE FORKLARING

 Denne afmærkning angiver, at dette produkt ikke må bortskaffes med andet husholdningsaffald inden for EU. For at forhindre mulig skade for miljøet eller menneskers sundhed på grund af ukontrolleret affaldsbortskaffelse, skal det genanvendes på ansvarlig vis for at fremme den bæredygtige genanvendelse af materielle ressourcer.

FKA Brands Ltd erklærer hermed, at dette radioudstyr efterlever de essentielle krav og andre relevante bestemmelser i Direktiv 2014/53/EU. En kopi af Overensstemmelseserklæringen kan fås hos

www.thehouseofmarley.co.uk/declaration-of-conformity

NO STIR IT UP LUX

LES ALLE INSTRUSJONENE FØR BRUK. TA VARE PÅ DISSE INSTRUKSJONENE FOR FREMTIDIG REFERANSE.

WEEE FORKLARING

 Denne merkingen indikerer at innen EU skal dette produktet ikke kastes sammen med annet husholdningssjøppel. For å forebygge mulig skade på miljøet eller menneskelig helse forårsaket av ukontrollert avfallstømming, skal produktet gjenvinnes ansvarlig for å støtte holdbar gjenbruk av materialressurser.

FKA Brands Ltd, erklærer herved at dette radioustyret samsvarer med nødvendige krav og andre relevante forholdsregler i direktiv 2014/53/EU. En kopi av konformitetserklæringen er tilgjengelig fra

www.thehouseofmarley.co.uk/declaration-of-conformity

EL STIR IT UP LUX

ΔΙΑΒΑΣΤΕ ΟΛΕΣ ΤΙΣ ΟΔΗΓΙΕΣ ΠΡΙΝ ΤΗ ΧΡΗΣΗ. ΦΥΛΑΞΤΕ ΑΥΤΕΣ ΤΙΣ ΟΔΗΓΙΕΣ

ΓΙΑ ΜΕΛΜΟΝΤΙΚΗ ΑΝΑΦΟΡΑ.

ΑΝΤΙΚΑΤΑΣΤΑΣΗ ΜΠΑΤΑΡΙΑΣ

Το ηχείο Stir It Up Wireless περιλαμβάνει μια επαναφορτιζόμενη μπαταρία ειδικά σχεδιασμένη ώστε να διαρκεί για όλη την ωφέλιμη ζωή του προϊόντος. Στην απίθανη περίπτωση που θα χρειαστείτε μπαταρία αντικατάστασης, επικοινωνήστε με την Εξυπηρέτηση Πελατών, η οποία θα σας δώσει λεπτομέρειες για αντικατάσταση της μπαταρίας εντός και εκτός εγγύησης.

ΟΔΗΓΙΑ ΓΙΑ ΤΙΣ ΜΠΑΤΑΡΙΕΣ

 Το σύμβολο αυτό υποδεικνύει ότι οι μπαταρίες δεν πρέπει να απορρίπτονται μαζί με οικιακά απορρίμματα, καθώς περιέχουν ουσίες που μπορεί να είναι επιβλαβείς για το περιβάλλον και την υγεία. Απορρίψτε τις μπαταρίες στα καθορισμένα σημεία συλλογής.

ΕΠΕΞΗΓΗΣΗ ΑΗΘΕ

 Αυτή η σήμανση επισημαίνει ότι αυτό το προϊόν δεν πρέπει να απορρίπτεται με άλλα οικιακά απόβλητα σε όλη την ΕΕ. Για να μην προκληθεί ζημιά στο περιβάλλον ή στην υγεία λόγω μη ελεγχόμενης απόρριψης αποβλήτων, ανακυκλώστε το υπεύθυνα, προάγοντας τη βιώσιμη επαναχρησιμοποίηση των υλικών πόρων.

Με το παρόν, η FKA Brands Ltd δηλώνει ότι αυτός ο ασύρματος εξοπλισμός συμμορφώνεται με τις ουσιαστικές απαιτήσεις και τις άλλες σχετικές προβλέψεις της Οδηγίας 2014/53/ΕΕ. Μπορείτε να αποκτήσετε ένα αντίγραφο της Δήλωσης Συμμόρφωσης αν επικοινωνήσετε με τη διεύθυνση

www.thehouseofmarley.co.uk/declaration-of-conformity

CZ STIR IT UP LUX

PŘED POUŽITÍM ZAŘÍZENÍ SI PŘEČTĚTE VŠECHNY POKYNY. POKYNY USCHOVEJTE PRO BUDOUCÍ NAHLÉDNUTÍ.

VYSVĚTLENÍ OEEZ

 Tato značka udává, že výrobek nesmí být na území EU vyhazován s běžným domácím odpadem. Pro prevenci možného znečištění životního prostředí a újmě na zdraví osob nekontrolovaným odpadem recyklujte výrobek odpovědným způsobem.

Společnost FKA Brands Ltd tímto prohlašuje, že toto rádiové vybavení je ve shodě se základními požadavky a dalšími relevantními ustanoveními směrnice 2014/53/EU. Kopii prohlášení o shodě získáte na adrese www.thehouseofmarley.co.uk/declaration-of-conformity

HU STIR IT UP LUX

HASZNÁLAT ELŐTT OLVASSA EL AZ UTASÍTÁSOKAT, ÉS A KÉSŐBBI HASZNÁLATHOZ TEGYE EL EZEKET.

WEEE-MAGYARÁZAT

 Ez a jelölés azt jelzi, hogy ezt a terméket az Európai Unióban nem szabad a háztartási hulladék közé dobni. Az ellenőrizetlen hulladékkezelésből származó környezeti vagy egészségügyi kár elkerülése végett, és a tárgyi készletek fenntartható kezelése jegyében felelősségteljesen hasznosítsa újra.

A FKA Brands Ltd. kijelenti, hogy ez a rádióberendezés eleget tesz a 2014/53/EU irányelv szükséges követelményeinek és egyéb vonatkozó rendelkezéseinek. A Megfelelőségi nyilatkozat másolatát a

www.thehouseofmarley.co.uk/declaration-of-conformity

PT STIR IT UP LUX

LEIA TODAS AS INSTRUÇÕES ANTES DE UTILIZAR. CONSERVE ESTAS INSTRUÇÕES PARA REFERÊNCIA FUTURA.

EXPLICAÇÃO DA REEE

 Esta marcação indica que o produto não deve ser eliminado juntamente com outros resíduos domésticos em toda a UE. Para impedir possíveis danos ambientais ou à saúde humana resultantes de uma eliminação não controlada dos resíduos, este produto deverá ser reciclado de forma responsável de modo a promover a reutilização sustentável dos recursos materiais.

Desta forma, o FKA Brands Ltd, declara que este equipamento de rádio está em conformidade com os requisitos essenciais outras provisões relevantes da Diretiva 2014/53/EU. É possível obter uma cópia da Declaração de Conformidade através do www.thehouseofmarley.co.uk/declaration-of-conformity

SK STIR IT UP LUX

PRED POUŽITÍM ZARIADENIA SI PREČÍTAJTE VŠETKY POKYNY. POKYNY USCHOVAJTE NA NAHLIADNUTIE V BUDÚCNOSTI.

WEEE POPIS

 Tento symbol znamená, že výrobok by sa v rámci celej EU nemá vyhazovať do domáceho odpadu. Aby nedošlo k možnému znečisteniu životného prostredia alebo poškodeniu zdravia v dôsledku nekontrolovaného odpadu, je potrebné pristupovať k recyklovaniu zodpovedne a propagovať tak opätovné použitie zdrojových materiálov.

Spoločnosť FKA Brands Ltd. týmto vyhlasuje, že toto rádiové zariadenie je v súlade so základnými požiadavkami a ďalšími relevantnými ustanoveniami Smernice 2014/53/EÚ. Kópiu vyhlásenia o zhode získate na adrese www.thehouseofmarley.co.uk/declaration-of-conformity

PL STIR IT UP LUX

PRZED UŻYCIEM NALEŻY PRZECZYTAĆ CAŁĄ INSTRUKCJĘ. INSTRUKCJĘ NALEŻY ZACHOWAĆ NA PRZYSZŁOŚĆ.

OBJAŚNIENIE WEEE

 Ten znak wskazuje, że na obszarze UE przyrzędu nie wolno pozbywać się wyrzucając do śmieci domowych. Aby chronić środowisko i zdrowie, którym zagraża nieodpowiednia utylizacja odpadów, przyrząd należy recyklingować, aby umożliwić odzysk materiałów, z których został wykonany.

Niniejszym firma FKA Brands Ltd oświadcza, że to urządzenie radiowe jest zgodne z podstawowymi wymaganiami oraz innymi właściwymi postanowieniami Dyrektywy 2014/53/EU. Kopię Deklaracji zgodności można uzyskać pod www.thehouseofmarley.co.uk/declaration-of-conformity

BG STIR IT UP LUX

ПРОЧЕТЕТЕ ВСИЧКИ ИНСТРУКЦИИ ПРЕДИ УПОТРЕБА И ГИ ЗАПАЗЕТЕ ЗА БЪДЕЩА СПРАВКА.

ПРЕДУПРЕЖДЕНИЕ: БАТЕРИИТЕ (КУТИЯТА С БАТЕРИИ ИЛИ ПОСТАВЕНИТЕ БАТЕРИИ) НЕ ТРЯБВА ДА СЕ ИЗЛАГАТ НА ПРЕКАЛЕНО ЗАТОПЛЯНЕ КАТО СЛЪНЧЕВА ТОПЛИНА, ОГЪН ИЛИ ДРУГИ ПОДОБНИ. ВНИМАНИЕ: ОПАСНОСТ ОТ ЕКСПЛОЗИЯ АКО БАТЕРИЯТА НЕ Е ПОСТАВЕНА ПРАВИЛНО. ЗАМЕНЕТЕ ЕДИНСТВЕНО СЪС СЪЩИЯ ИЛИ С ПОДОБЕН ВИД.

ЗАМЯНА НА БАТЕРИЯТА:

Вашият Stir It Up Wireless включва зареждащи се батерии, предназначени да издържат през целия живот на продукта. В малко вероятния случай, когато се наложи замяна на батерията, моля свържете се с отдела за клиентско обслужване, който ще Ви осигури информация за гаранцията и услугата за замяна на батерията извън гаранция.

ДИРЕКТИВА ЗА БАТЕРИЯТА

 Този символ показва, че батериите не трябва да се изхвърлят с битовите отпадъци, защото съдържат вещества, които може да са опасни за околната среда и за здравето. Моля, изхвърляйте батериите на предназначения за тази цел места.

ОБЕО ОБЯСНЕНИЕ

 Това маркиране показва, че този продукт не трябва да се изхвърля с други битови отпадъци в границите на ЕС. За предотвратяване на евентуална щета за околната среда или за човешкото здраве поради неконтролирано изхвърляне на боклука, рециклирайте го отговорно, за да съдействате за екологичната многократна употреба на материалните ресурси.

С настоящето, FKA Brands Ltd, декларира, че това радиосъоръжение е в съответствие на основните изисквания и на други необходими условия на Директива 2014/53/EU. Копие от Декларацията за съответствие може да бъде получено от www.thehouseofmarley.co.uk/declaration-of-conformity

RO STIR IT UP LUX

CITIȚI TOATE INSTRUCȚIUNILE ÎNAINTE DE UTILIZARE ȘI PĂSTRAȚI-LE PENTRU A LE CONSULTA ÎN VIITOR.

ÎNLOCUIREA BATERIILOR

Difuzorul Stir It Up LUX include un acumulator conceput să reziste pe toată durata de viață a produsului. În cazul improbabil în care ați fi obligat să înlocuiți acumulatorul, contactați Serviciul Clienți care vă va informa cu privire la garanția produsului dumneavoastră și la înlocuirea acumulatorului după expirarea garanției.

EXPLICAȚIA DEEE

 Acest simbol indică faptul că acest produs nu trebuie eliminat împreună cu alte deșeuri menajere pe teritoriul UE. Pentru a preveni posibile prejudicii asupra mediului sau sănătății umane din cauza eliminării necontrolate a deșeurilor, reciclați-l cu responsabilitate pentru a favoriza reutilizarea durabilă a resurselor materiale.

FKA Brands Ltd declară că acest dispozitiv radio este în conformitate cu cerințele esențiale și alte prevederi relevante ale Directivei 2014/53/EU. Un exemplar al Declarației de conformitate poate obținut de la

www.thehouseofmarley.co.uk/declaration-of-conformity

AR STIR IT UP LUX

اقرأ كل الإرشادات وافهمها قبل استخدام المنتج بعناية والاحتفاظ بها للرجوع إليها.

مخلفات الأجهزة الكهربائية / الإلكترونية

 يشير هذا الرمز إلى أن المنتج ينبغي عدم التخلص منه مع سائر المخلفات المنزلية الأخرى في جميع أنحاء الاتحاد الأوروبي. لتفادي احتمال وقوع الضرر على البيئة أو الصحة البشرية بسبب التخلص من النفايات بطرق غير خاضعة للصواب، يرجى إعادة تدويرها على نحو مسؤول لتعزيز إعادة الاستخدام المستدام العربية

تقر FKA Brands Ltd بموجب أن هذا الجهاز اللاسلكي يأتي متوافقاً مع المتطلبات اللازمة وغيره من الأحكام ذات الصلة من الأمر الإرشادي 2014/53/EU. ويمكن الحصول على نسخة من إعلان المطابقة على

www.thehouseofmarley.co.uk/declaration-of-conformity

CN STIR IT UP LUX

使用之前請閱讀所有指南並妥善保存以備未來參考

歐共體廢棄電子電器設備指南(WEEE)解釋

此標識表示在歐共體內本產品不得與家庭物色一起丟棄。無控制的物色丟棄有害環境或健康，必須避免。請盡力回收廢舊設備，使其持續得以再生利用。

FKA分銷有限公司在此聲明，此無線設備符合2014/53/EU指南的基本要求和和其它相關條款。請訪問www.thehouseofmarley.co.uk/declaration-of-conformity以獲取合規聲明的副本。

NCC WARNING MESSAGE

低功率電波輻射性電機管理辦法

第十二條 經型式認證合格之低功率射頻電機，非經許可，公司、商號或使用者均不得擅自變更頻率、加大功率或變更原設計之特性及功能。

第十四條 低功率射頻電機之使用不得影響飛航安全及干擾合法通信；經發現有干擾現象時，應改善至無干擾時方得繼續使用。

前項合法通信，指依電信法規定作業之無線電通信。

ID STIR IT UP LUX

BACA SEMUA PETUNJUK SEBELUM PENGGUNAAN DAN SIMPAN PETUNJUK INI UNTUK RUJUKAN DI MASA MENDATANG.

PENJELASAN WEEE

 Tanda ini menunjukkan bahwa produk ini tidak boleh dibuang bersama sampah rumah tangga lain di seluruh UE. Untuk mencegah kemungkinan bahaya pada lingkungan atau kesehatan manusia dari pembuangan limbah yang tidak terkendali, daur ulang produk ini secara bertanggung jawab untuk mempromosikan penggunaan kembali sumber daya bahan secara berkelanjutan.

FKA Brands Ltd dengan ini menyatakan bahwa peralatan radio ini mematuhi persyaratan penting dan ketentuan relevan lainnya dari Arahan 2014/53/EU. Salinan Pernyataan Kepatuhan bisa diperoleh dari

www.thehouseofmarley.co.uk/declaration-of-conformity



To prevent possible hearing damage, do not listen at high volume levels for long periods.

Full instruction and warranty details can be found at <http://www.thehouseofmarley.com/instructionbooks>

Con el fin de evitar lesiones auditivas, se aconseja no

escuchar a un volumen excesivamente alto durante un periodo prolongado. Para ver los detalles completos y las excepciones, consulte <http://www.thehouseofmarley.com/instructionbooks>.

Afin d'éviter tout dommage auditif possible, ne pas écouter à un volume sonore élevé pendant une période prolongée. Pour les informations complètes et les exceptions, rendez-vous sur <http://www.thehouseofmarley.com/instructionbooks>.

Um mögliche Hörschäden zu vermeiden, stellen Sie die Lautstärke nicht über einen längeren Zeitraum sehr hoch ein. Weitere Informationen und Ausnahmen erhalten Sie hier <http://www.thehouseofmarley.com/instructionbooks>.

Per evitare possibili danni all'udito, non ascoltare audio a livelli elevati di volume per lunghi periodi. Per tutti i dettagli e le eccezioni, visitare il sito <http://www.thehouseofmarley.com/instructionbooks>.



인증받은자의 상호: (주)디엠에이씨인터내셔널
 제품명/모델명:특정소출력무선기기(무선데이터통신시스템용무선기기)/EM-JT010
 제조자 및 제조국가: FKA Distributing Co., LLC / China
 인증번호: R-C-DMV-EM-JT010, EM-JT010
 제품명 (Product name): Stir It Up LUX Turntable
 모델명 (Model): EM-JT010
 무선 방식 (Operation Frequency): Bluetooth (2402 - 2480 MHz)
 채널 (Radio Channel): 79channels for BDR/EDR
 무선 채널 (Bluetooth Mode): BT 5.3
 출력 (Output Power): 3mW
 안테나 이득 (Antenna Gain): 0dB
 변조 형식 (Modulation Type): GFSK, $\pi/4$ -DQPSK
 전원 (Power Supply): 15 V

Marley and the Marley logo are registered trademarks of Fifty-Six Hope Road Music Limited and the use of such marks by House of Marley is under license. The Bluetooth® word mark and logos are registered trademarks owned by Bluetooth® SIG, Inc. and any use of such marks by The House of Marley is under license.

Operating frequency band: 2402 – 2480MHz
 CE Maximum radio-frequency power transmitted: 2.64dBm

DISTRIBUTED BY:
 The House of Marley, LLC
 3000 North Pontiac Trail, Commerce Township,
 MI 48390 USA

Imported into the UK by
 FKA Brands Ltd, Tonbridge, TN10GP, UK.

Imported into the EU by
 FKA Brands Ltd, 29 Earlsfort Terrace, Dublin 2. IE

Distributed in Australia by
 Homedics Australia Pty Ltd
 14 Kingsley Close
 Rowville, Victoria 3178







Distributed in New Zealand by
 CDB Media Ltd
 4 Lovell Court
 Albany, Auckland, New Zealand 0800 232 633

IB-EMJT010SB-1222-01

 EM-JT010
 © 2023 House of Marley, LLC.
 All Rights Reserved.



201-220575

	<p>RECYCLING This product bears the selective sorting symbol for Waste electrical and electronic equipment (WEEE). This means that this product must be handled pursuant to European directive 2012/19/EU in order to be recycled or dismantled to minimize its impact on the environment. User has the choice to give his product to a competent recycling organization or to the retailer when he buys a new electrical or electronic equipment</p>
	<p>This symbol indicates class II equipment</p>
	<p>This symbol indicates AC voltage</p>
	<p>This symbol indicates for indoor use only</p>
	<p>This symbol indicates DC voltage</p>
	<p>This symbol indicates energy efficiency marking</p>
<p>The power adaptor plug is used as the disconnect device, The connected AC power outlet must be located near the equipment and be easily accessible.</p>	
<p>The marking information is located at the bottom of the apparatus.</p>	
<p>WARNING: Only the accessories (such as external power supply) provided by the manufacturer can be used with the product.</p>	
<p>Adapter Information Manufacturer : Shenzhen Aquilstar Technology Co, Ltd. Model: ASS A107 W- 150080 Input: 100-240 V-50/60Hz 0.45A Output: 15.0V , 0.8A, 12W</p>	

STIR IT UP LUX

QUICK START GUIDE

TheHouseofMarley.com



BOB MARLEY™
MARLEY™
BOBMARLEY.COM

©Fifty-Six Hope Road Music Ltd., 2011-2023.
Right of Publicity and Persona Rights.
Fifty-Six Hope Road Music Ltd. EM-JT010

Marley, the Marley logo, Bob Marley and the Bob Marley logo are registered trademarks of Fifty-Six Hope Road Music Limited and any use of such marks by The House of Marley is under license. The Bluetooth® word mark and logos are registered trademarks owned by Bluetooth® SIG, Inc. and any use of such marks by The House of Marley is under license.

